



Programmable Controller

MELSEC iQ-F
series



MELSEC iQ-F

FX5 User's Manual (Temperature Control)

SAFETY PRECAUTIONS

(Read these precautions before use.)

Before using this product, please read this manual and the relevant manuals introduced in this manual carefully and pay full attention to safety in order to handle the product correctly.

This manual classifies the safety precautions into two categories: [ WARNING] and [ CAUTION].



WARNING

Indicates that incorrect handling may cause hazardous conditions, resulting in death or severe injury.



CAUTION

Indicates that incorrect handling may cause hazardous conditions, resulting in minor or moderate injury or property damage.

Depending on the circumstances, procedures indicated by [ CAUTION] may also cause severe injury.

It is important to follow all precautions for personal safety.

Store this manual in a safe place so that it can be read whenever necessary. Always forward it to the end user.

[DESIGN PRECAUTIONS]



WARNING

- Make sure to set up the following safety circuits outside the PLC to ensure safe system operation even during external power supply problems or PLC failure. Otherwise, malfunctions may cause serious accidents.
 - Most importantly, set up the following: an emergency stop circuit, a protection circuit, an interlock circuit for opposite movements (such as normal vs. reverse rotation), and an interlock circuit to prevent damage (to the equipment at the upper and lower positioning limits).
 - Note that when the CPU module detects an error, such as a watchdog timer error, during self-diagnosis, all outputs are turned off. Also, when an error that cannot be detected by the CPU module occurs in an input/output control block, output control may be disabled. External circuits and mechanisms should be designed to ensure safe machinery operation in such a case.
 - Note that when an error occurs in a relay, transistor or triac of an output circuit, the output might stay on or off. For output signals that may lead to serious accidents, external circuits and mechanisms should be designed to ensure safe machinery operation in such a case.
 - In an output circuit, when a load current exceeding the current rating or an overcurrent caused by a load short-circuit flows for a long time, it may cause smoke and fire. To prevent this, configure an external safety circuit, such as a fuse.
 - Construct an interlock circuit in the program so that the whole system always operates on the safe side before executing the control (for data change) of the PLC in operation.

Read the manual thoroughly and ensure complete safety before executing other controls (for program change, parameter change, forcible output and operation status change) of the PLC in operation. Otherwise, the machine may be damaged and accidents may occur due to erroneous operations.
 - Do not write any data to the "system area" and "write-protect area" of the buffer memory in the module. Executing data writing to the "system area" or "write protect area" may cause malfunction of the programmable controller alarm. For the "system area" or "write-protect area", refer to  Page 99 Buffer Memory Areas.
-

[DESIGN PRECAUTIONS]

CAUTION

- When an inductive load such as a lamp, heater, or solenoid valve is controlled, a large current (approximately ten times greater than normal) may flow when the output is turned from off to on. Take proper measures so that the flowing current dose not exceed the value corresponding to the maximum load specification of the resistance load.
 - Simultaneously turn on and off the power supplies of the CPU module and extension modules.
-

[INSTALLATION PRECAUTIONS]

WARNING

- Make sure to cut off all phases of the power supply externally before attempting installation or wiring work. Failure to do so may cause electric shock or damage to the product.
 - This product is an open type device that must be installed and used within a control cabinet which satisfies all of the following three requirements.
 - a cabinet which has conductivity.
 - a cabinet which has a structure to prevent the fire to spread outside the cabinet.
 - a cabinet which has sufficient mechanical strength.
 - Use the product within the generic environment specifications described in the User's Manual (Hardware) of the CPU module used.

Never use the product in areas with excessive dust, oily smoke, conductive dusts, corrosive gas (salt air, Cl₂, H₂S, SO₂ or NO₂), flammable gas, vibration or impacts, or expose it to high temperature, condensation, or rain and wind.

If the product is used in such conditions, electric shock, fire, malfunctions, deterioration or damage may occur.
-

[INSTALLATION PRECAUTIONS]

CAUTION

- Do not touch the conductive parts of the product directly. Doing so may cause device failures or malfunctions.
 - When drilling screw holes or wiring, make sure that cutting and wiring debris do not enter the ventilation slits of the PLC. Failure to do so may cause fire, equipment failures or malfunctions.
 - For the product supplied together with a dust proof sheet, the sheet should be affixed to the ventilation slits before the installation and wiring work to prevent foreign objects such as cutting and wiring debris.
However, when the installation work is completed, make sure to remove the sheet to provide adequate ventilation. Failure to do so may cause fire, equipment failures or malfunctions.
 - Install the product on a flat surface. If the mounting surface is rough, undue force will be applied to the PC board, thereby causing nonconformities.
 - Install the product securely using a DIN rail or mounting screws.
 - Work carefully when using a screwdriver such as installation of the product. Failure to do so may cause damage to the product or accidents.
 - Connect the extension cables, peripheral device cables, input/output cables and battery connecting cable securely to their designated connectors. Loose connections may cause malfunctions.
 - Turn off the power to the PLC before attaching or detaching the following devices. Failure to do so may cause device failures or malfunctions.
 - Peripheral devices, expansion board, expansion adapter, and connector conversion adapter
 - Extension modules, bus conversion module, and connector conversion module
 - Battery
-

[WIRING PRECAUTIONS]

WARNING

- Make sure to cut off all phases of the power supply externally before attempting installation or wiring work. Failure to do so may cause electric shock or damage to the product.
 - Make sure to attach the terminal cover, provided as an accessory, before turning on the power or initiating operation after installation or wiring work. Failure to do so may cause electric shock.
 - Don't use the input terminals for measurement on a main circuit, since those terminals have no measurement category.
 - The temperature rating of the cable should be 80°C or more.
 - Make sure to properly wire to the spring clamp terminal block in accordance with the following precautions. Failure to do so may cause electric shock, equipment failures, a short-circuit, wire breakage, malfunctions, or damage to the product.
 - The disposal size of the cable end should follow the dimensions described in the manual.
 - Twist the ends of stranded wires and make sure that there are no loose wires.
 - Do not solder-plate the electric wire ends.
 - Do not connect more than the specified number of wires or electric wires of unspecified size.
 - Affix the electric wires so that neither the terminal block nor the connected parts are directly stressed.
-

[WIRING PRECAUTIONS]

CAUTION

- Perform class D grounding (grounding resistance: 100 Ω or less) of the grounding terminal on the CPU module and extension modules with a wire 2 mm² or thicker.
Do not use common grounding with heavy electrical systems ( Page 73 Grounding).
 - Connect the power supply wiring to the dedicated terminals described in this manual. If an AC power supply is connected to a DC input/output terminal or DC power supply terminal, the PLC will burn out.
 - Do not wire vacant terminals externally. Doing so may damage the product.
 - Install module so that excessive force will not be applied to terminal blocks, power connectors, I/O connectors, communication connectors, or communication cables. Failure to do so may result in wire damage/breakage or PLC failure.
 - Make sure to observe the following precautions in order to prevent any damage to the machinery or accidents due to malfunction of the PLC caused by abnormal data written to the PLC due to the effects of noise:
 - Do not bundle the power line, control line and communication cables together with or lay them close to the main circuit, high-voltage line, load line or power line. As a guideline, lay the power line, control line and connection cables at least 100 mm away from the main circuit, high-voltage line, load line or power line.
 - Ground the shield of the analog input/output cable in accordance with the manuals of each model. However, do not use common grounding with heavy electrical systems.
 - Check the interface type and correctly connect the cable. Incorrect wiring (connecting the cable to an incorrect interface) may cause failure of the module and external device.
 - To terminal blocks or power connectors, connect circuits isolated from hazardous voltage by double/reinforced insulation.
-

[STARTUP AND MAINTENANCE PRECAUTIONS]

WARNING

- Do not touch any terminal while the PLC's power is on. Doing so may cause electric shock or malfunctions.
 - Before cleaning or retightening terminals, cut off all phases of the power supply externally. Failure to do so in the power ON status may cause electric shock.
 - Before modifying the program in operation, forcible output, running or stopping the PLC, read through this manual carefully, and ensure complete safety. An operation error may damage the machinery or cause accidents.
 - Do not change the program in the PLC from two or more peripheral equipment devices at the same time. (i. e. from an engineering tool and a GOT) Doing so may cause destruction or malfunction of the PLC program.
-

[STARTUP AND MAINTENANCE PRECAUTIONS]

CAUTION

- Do not disassemble or modify the PLC. Doing so may cause fire, equipment failures, or malfunctions. For repair, contact your local Mitsubishi Electric representative.
 - Turn off the power to the PLC before connecting or disconnecting any extension cable. Failure to do so may cause device failures or malfunctions.
 - Turn off the power to the PLC before attaching or detaching the following devices. Failure to do so may cause device failures or malfunctions.
 - Peripheral devices, expansion board, expansion adapter, and connector conversion adapter
 - Extension modules, bus conversion module, and connector conversion module
 - Battery
-

[OPERATION PRECAUTIONS]

CAUTION

- Construct an interlock circuit in the program so that the whole system always operates on the safe side before executing the control (for data change) of the PLC in operation. Read the manual thoroughly and ensure complete safety before executing other controls (for program change, parameter change, forcible output and operation status change) of the PLC in operation. Otherwise, the machine may be damaged and accidents may occur by erroneous operations.
 - Note that the whole system may not be reset by the RUN/STOP/RESET switch when the CPU module or intelligent function module detects an error, such as a watchdog timer error, during self-diagnosis.
In that case, turn off and on the power.
-

[DISPOSAL PRECAUTIONS]

CAUTION

- Please contact a certified electronic waste disposal company for the environmentally safe recycling and disposal of your device.
-

[TRANSPORTATION PRECAUTIONS]

CAUTION

- The PLC is a precision instrument. During transportation, avoid impacts larger than those specified in the general specifications of the User's Manual (Hardware) of the CPU module used by using dedicated packaging boxes and shock-absorbing pallets. Failure to do so may cause failures in the PLC. After transportation, verify operation of the PLC and check for damage of the mounting part, etc.
-

INTRODUCTION

This manual contains text, diagrams and explanations which will guide the reader in the correct installation, safe use and operation of the temperature control module of MELSEC iQ-F series and should be read and understood before attempting to install or use the module.

Always forward it to the end user.

Regarding use of this product

- This product has been manufactured as a general-purpose part for general industries, and has not been designed or manufactured to be incorporated in a device or system used in purposes related to human life.
- Before using the product for special purposes such as nuclear power, electric power, aerospace, medicine or passenger movement vehicles, consult Mitsubishi Electric.
- This product has been manufactured under strict quality control. However when installing the product where major accidents or losses could occur if the product fails, install appropriate backup or failsafe functions in the system.

Note

- If in doubt at any stage during the installation of the product, always consult a professional electrical engineer who is qualified and trained in the local and national standards. If in doubt about the operation or use, please consult the nearest Mitsubishi Electric representative.
- Since the examples indicated by this manual, technical bulletin, catalog, etc. are used as a reference, please use it after confirming the function and safety of the equipment and system. Mitsubishi Electric will accept no responsibility for actual use of the product based on these illustrative examples.
- This manual content, specification etc. may be changed, without a notice, for improvement.
- The information in this manual has been carefully checked and is believed to be accurate; however, if you notice a doubtful point, an error, etc., please contact the nearest Mitsubishi Electric representative. When doing so, please provide the manual number given at the end of this manual.

MEMO

CONTENTS

SAFETY PRECAUTIONS	1
INTRODUCTION	6
RELEVANT MANUALS	12
TERMS	13
CHAPTER 1 DESCRIPTION	15
CHAPTER 2 SPECIFICATIONS	16
2.1 General Specifications	16
2.2 Power Supply Specifications	16
2.3 Performance Specifications	16
Input specifications	17
Measurement precision	17
Current detector (CT) input specifications	18
Process values	19
Measured temperature range	19
Output specifications	19
2.4 Part Names	20
LED display	20
CHAPTER 3 PROCEDURES BEFORE OPERATION	21
CHAPTER 4 FUNCTION	22
4.1 Functions List	22
4.2 Control Mode Selection Function	24
4.3 Control Method	26
4.4 Manual Control	30
4.5 Balance Bumpless Function	31
4.6 RFB Limiter Function	31
4.7 Simple Two-degree-of-freedom	32
4.8 Normal/Reverse Operation Selection Function	32
4.9 Proportional Band Setting Function	33
4.10 Overlap/dead Band Function	34
4.11 Cooling Method Setting Function	35
4.12 Auto Tuning Function	36
4.13 AT (Auto Tuning) Bias Function	40
4.14 Startup Tuning Function	41
4.15 Operations Mode Selection Function	43
4.16 Cascade Control	44
4.17 SV Tracking Function	46
4.18 Settings Limiter Function	46
4.19 Setting Change Rate Limiter Setting Function	47
4.20 Input Type Selection Function	47
4.21 Sensor Correction Function	48
4.22 Primary Delay Digital Filter	49
4.23 Temperature Rise Judgment Function	50
4.24 External (Other Analog Module) I/O Function	50
4.25 Output Limiter Function	51

4.26	Output Change Ratio Limiter Function	52
4.27	Control Output Flag	52
4.28	Transistor Outputs Selection Function	53
4.29	Alert Function	54
4.30	Loop Disconnection Detection Function	61
4.31	Loop Disconnection Detection Dead Band Function	62
4.32	Heater Disconnection Detection Function	63
4.33	Output OFF-time Current Error Detection Function	63
4.34	Buffer Memory Data Backup Function	64
4.35	Default Function	65
4.36	Error History Function	65
4.37	FX3 Allocation Mode Function	68
CHAPTER 5 SYSTEM CONFIGURATION		69
5.1	Overall Configuration	69
CHAPTER 6 WIRING		70
6.1	Spring Clamp Terminal Block	70
6.2	Terminals Layout	72
6.3	Power Supply Wiring	73
	Grounding	73
6.4	External Wiring Example	74
CHAPTER 7 PARAMETER SETTING		77
7.1	Base Setting	77
7.2	Application Setting	78
7.3	CT Setting	79
7.4	Refresh Setting	80
CHAPTER 8 PROGRAMMING		81
8.1	Programming Procedure	81
	Standard PID control	81
	Heating-cooling PID control	87
CHAPTER 9 TROUBLESHOOTING		90
9.1	Checks with LEDs	90
	The POWER LED has turned OFF	90
	The RUN LED has turned OFF	90
	When the ERROR LED turns on or flashes	90
9.2	Checks When Trouble Occurs	91
9.3	List of Error Codes	92
9.4	List of Alarm Codes	94
APPENDIX		95
Appendix 1 External Dimensions		95
Appendix 2 Standards		96
	Certification of UL, cUL standards	96
	Compliance with EC directive (CE Marking)	96
	Requirement for compliance with EMC directive	96
Appendix 3 Module Label		98

Appendix 4 Buffer Memory Areas	99
List of buffer memory addresses	99
Details of buffer memory addresses	117
Appendix 5 PID	166
PID operations.....	166
Actions of the temperature control module	167
Proportional action (P action)	168
Integral action (I action).....	169
Derivative action (D action)	170
PID action	170
INDEX	171
<hr/>	
REVISIONS	174
WARRANTY	175
TRADEMARKS	176

RELEVANT MANUALS

Manual name <manual number>	Description
MELSEC iQ-F FX5 User's Manual (Startup) <JY997D58201>	Performance specifications, procedures before operation, and troubleshooting of the CPU module.
MELSEC iQ-F FX5UJ User's Manual (Hardware) <SH-082206ENG>	Describes the details of hardware of the FX5UJ CPU module, including input/output specifications, wiring, installation, and maintenance.
MELSEC iQ-F FX5U User's Manual (Hardware) <JY997D55301>	Describes the details of hardware of the FX5U CPU module, including input/output specifications, wiring, installation, and maintenance.
MELSEC iQ-F FX5UC User's Manual (Hardware) <JY997D61401>	Describes the details of hardware of the FX5UC CPU module, including input/output specifications, wiring, installation, and maintenance.
MELSEC iQ-F FX5 User's Manual (Application) <JY997D55401>	Describes basic knowledge required for program design, functions of the CPU module, devices/labels, and parameters.
MELSEC iQ-F FX5 Programming Manual (Program Design) <JY997D55701>	Describes specifications of ladders, ST, FBD/LD, and other programs and labels.
MELSEC iQ-F FX5 Programming Manual (Instructions, Standard Functions/Function Blocks) <JY997D55801>	Describes specifications of instructions and functions that can be used in programs.
MELSEC iQ-F FX5 User's Manual (Serial Communication) <JY997D55901>	Describes N:N network, Parallel link, MELSEC Communication protocol, inverter communication, non-protocol communication, and predefined protocol support.
MELSEC iQ-F FX5 User's Manual (MELSEC Communication Protocol) <JY997D60801>	Explains methods for the device that is communicating with the CPU module by MC protocol to read and write the data of the CPU module.
MELSEC iQ-F FX5 User's Manual (MODBUS Communication) <JY997D56101>	Describes MODBUS serial communication and MODBUS/TCP communication.
MELSEC iQ-F FX5 User's Manual (PROFIBUS) <SH-081910ENG>	Describes the functions of the PROFIBUS-DP master module.
MELSEC iQ-F FX5 User's Manual (Ethernet Communication) <JY997D56201>	Describes the Ethernet communication function of the CPU module built-in and the Ethernet module.
MELSEC iQ-F FX5-ENET User's Manual <SH-082026ENG>	Describes the functions of the Ethernet module.
MELSEC iQ-F FX5-ENET/IP User's Manual <SH-082027ENG>	Describes the functions of the FX5-ENET/IP.
MELSEC iQ-F FX5 User's Manual (SLMP) <JY997D56001>	Explains methods for the device that is communicating with the CPU module by SLMP to read and write the data of the CPU module.
MELSEC iQ-F FX5 User's Manual (CC-Link IE) <JY997D64201>	Describes CC-Link IE field network module.
MELSEC iQ-F FX5 User's Manual (CC-Link) <SH-081793ENG>	Describes CC-Link system master/intelligent device module.
MELSEC iQ-F FX5 User's Manual (AnyWireASLINK) <SH-081796ENG>	Describes AnyWireASLINK system master module.
MELSEC iQ-F FX5 User's Manual (Positioning Control - CPU module built-in, High-speed pulse input/output module) <JY997D56301>	Describes the positioning function of the CPU module built-in and the high-speed pulse input/output module.
MELSEC iQ-F FX5 User's Manual (Positioning Control - Intelligent function module) <SH-081805ENG>	Describes the positioning module.
MELSEC iQ-F FX5 Simple Motion Module User's Manual (Startup) <IB0300251>	Specifications, procedures before operation, system configuration, wiring, and operation examples of the Simple Motion module.
MELSEC iQ-F FX5 Simple Motion Module User's Manual (Application) <IB0300253>	Functions, input/output signals, buffer memories, parameter settings, programming, and troubleshooting of the Simple Motion module.
MELSEC iQ-F FX5 Simple Motion Module User's Manual (Advanced Synchronous Control) <IB0300255>	Functions and programming for the synchronous control of the Simple Motion module.
MELSEC iQ-F FX5 User's Manual (Analog Control - CPU module built-in, Expansion adapter) <JY997D60501>	Describes the analog function of the CPU module built-in and the analog adapter.
MELSEC iQ-F FX5 User's Manual (Analog Control - Intelligent function module) <SH-081802ENG>	Describes the analog input module, analog output module, and multiple input module.
MELSEC iQ-F FX5 User's Manual (Temperature Control) <SH-081799ENG> (This manual)	Describes the temperature control module.

Manual name <manual number>	Description
MELSEC iQ-F FX5 User's Manual (Safety Control) <SH-082078ENG>	Describes the safety extension modules.
GX Works3 Operating Manual <SH-081215ENG>	System configuration, parameter settings, and online operations of GX Works3.
Transition from MELSEC FX3G, FX3U, FX3UC Series to MELSEC iQ-F Series Handbook <JY997D66201>	Describes the transition from MELSEC FX3G/FX3U/FX3UC series to MELSEC iQ-F series.

TERMS

Unless otherwise specified, this manual uses the following terms.

For details on the FX3 devices that can be connected with the FX5, refer to the User's Manual (Hardware) of the CPU module to be used.

Terms	Description
■Devices	
FX5	Generic term for FX5UJ, FX5U and FX5UC PLCs
FX3	Generic term for FX3S, FX3G, FX3GC, FX3U, and FX3UC PLCs
FX5 CPU module	Generic term for FX5UJ CPU module, FX5U CPU module and FX5UC CPU module
FX5UJ CPU module	Generic term for FX5UJ-24MR/ES, FX5UJ-24MT/ES, FX5UJ-24MT/ESS, FX5UJ-40MR/ES, FX5UJ-40MT/ES, FX5UJ-40MT/ESS, FX5UJ-60MR/ES, FX5UJ-60MT/ES, and FX5UJ-60MT/ESS
FX5U CPU module	Generic term for FX5U-32MR/ES, FX5U-32MT/ES, FX5U-32MT/ESS, FX5U-64MR/ES, FX5U-64MT/ES, FX5U-64MT/ESS, FX5U-80MR/ES, FX5U-80MT/ES, FX5U-80MT/ESS, FX5U-32MR/DS, FX5U-32MT/DS, FX5U-32MT/DSS, FX5U-64MR/DS, FX5U-64MT/DS, FX5U-64MT/DSS, FX5U-80MR/DS, FX5U-80MT/DS, and FX5U-80MT/DSS
FX5UC CPU module	Generic term for FX5UC-32MT/D, FX5UC-32MT/DSS, FX5UC-64MT/D, FX5UC-64MT/DSS, FX5UC-96MT/D, FX5UC-96MT/DSS, FX5UC-32MT/DS-TS, FX5UC-32MT/DSS-TS, and FX5UC-32MR/DS-TS
Extension module	Generic term for FX5 extension modules, FX3 function modules, Extension modules (extension cable type), and Extension module (extension connector type)
FX5 extension module	Generic term for I/O modules, FX5 extension power supply modules, FX5 intelligent function modules, and FX5 safety extension modules
FX3 extension module	Generic term for FX3 extension power supply module and FX3 intelligent function module
Extension module (extension cable type)	Generic term for Input modules (extension cable type), Output modules (extension cable type), Input/output modules (extension cable type), Powered input/output module, High-speed pulse input/output module, Extension power supply module (extension cable type), Connector conversion module (extension cable type), Intelligent function modules, Safety extension modules, and Bus conversion module (extension cable type)
Extension module (extension connector type)	Generic term for Input modules (extension connector type), Output modules (extension connector type), Input/output modules (extension connector type), Extension power supply module (extension connector type), Connector conversion module (extension connector type), and Bus conversion module (extension connector type)
I/O module	Generic term for Input modules, Output modules, Input/output modules, Powered input/output modules, and High-speed pulse input/output modules
Input module	Generic term for Input modules (extension cable type) and Input modules (extension connector type)
Input module (extension cable type)	Generic term for FX5-8EX/ES and FX5-16EX/ES
Input module (extension connector type)	Generic term for FX5-C16EX/D, FX5-C16EX/DS, FX5-C32EX/D, FX5-C32EX/DS, and FX5-C32EX/DS-TS
Output module	Generic term for Output modules (extension cable type) and Output modules (extension connector type)
Output module (extension cable type)	Generic term for FX5-8EYR/ES, FX5-8EYT/ES, FX5-8EYT/ESS, FX5-16EYR/ES, FX5-16EYT/ES, and FX5-16EYT/ESS
Output module (extension connector type)	Generic term for FX5-C16EYT/D, FX5-C16EYT/DSS, FX5-C16EYR/D-TS, FX5-C32EYT/D, FX5-C32EYT/DSS, FX5-C32EYT/D-TS, and FX5-C32EYT/DSS-TS
Input/output module	Generic term for Input/output modules (extension cable type) and Input/output modules (extension connector type)
Input/output module (extension cable type)	Generic term for FX5-16ER/ES, FX5-16ET/ES, and FX5-16ET/ESS
Input/output module (extension connector type)	Generic term for FX5-C32ET/D, FX5-C32ET/DSS, FX5-C32ET/DS-TS, and FX5-C32ET/DSS-TS
Powered input/output module	Generic term for FX5-32ER/ES, FX5-32ET/ES, FX5-32ET/ESS, FX5-32ER/DS, FX5-32ET/DS, and FX5-32ET/DSS
High-speed pulse input/output module	Generic term for FX5-16ET/ES-H and FX5-16ET/ESS-H
Extension power supply module	Generic term for FX5 extension power supply module and FX3 extension power supply module

Terms	Description
FX5 extension power supply module	Generic term for FX5 extension power supply module (extension cable type) and FX5 extension power supply module (extension connector type)
FX5 extension power supply module (extension cable type)	Different name for FX5-1PSU-5V
FX5 extension power supply module (extension connector type)	Different name for FX5-C1PS-5V
FX3 extension power supply module	Different name for FX3U-1PSU-5V
Intelligent module	The abbreviation for intelligent function modules
Intelligent function module	Generic term for FX5 intelligent function modules and FX3 intelligent function modules
FX5 intelligent function module	Generic term for FX5-4AD, FX5-4DA, FX5-8AD, FX5-4LC, FX5-20PG-P, FX5-20PG-D, FX5-40SSC-S, FX5-80SSC-S, FX5-ENET, FX5-ENET/IP, FX5-CCLIEF, FX5-CCL-MS, FX5-ASL-M, and FX5-DP-M
FX3 intelligent function module	Generic term for FX3U-4AD, FX3U-4DA, FX3U-4LC, FX3U-1PG, FX3U-2HC, FX3U-16CCL-M, FX3U-64CCL, FX3U-128ASL-M, and FX3U-32DP
FX5 safety extension module	Generic term for safety main modules and safety expansion modules
Safety main module	Different name for FX5-SF-MU4T5
Safety expansion module	Generic term for expansion modules installed to a safety main module
Safety input expansion module	Different name for FX5-SF-8DI4
Expansion board	Generic term for board for FX5UJ CPU module and FX5U CPU module
Communication board	Generic term for FX5-232-BD, FX5-485-BD, and FX5-422-BD-GOT
Expansion adapter	Generic term for adapter for FX5 CPU module
Communication adapter	Generic term for FX5-232ADP and FX5-485ADP
Analog adapter	Generic term for FX5-4AD-ADP, FX5-4DA-ADP, FX5-4AD-PT-ADP, and FX5-4AD-TC-ADP
Bus conversion module	Generic term for Bus conversion module (extension cable type) and Bus conversion module (extension connector type)
Bus conversion module (extension cable type)	Different name for FX5-CNV-BUS
Bus conversion module (extension connector type)	Different name for FX5-CNV-BUSC
Connector conversion module	Generic term for Connector conversion module (extension cable type) and Connector conversion module (extension connector type)
Connector conversion module (extension cable type)	Different name for FX5-CNV-IF
Connector conversion module (extension connector type)	Different name for FX5-CNV-IFC
Extended extension cable	Generic term for FX5-30EC and FX5-65EC
Connector conversion adapter	Different name for FX5-CNV-BC
Battery	Different name for FX3U-32BL
Peripheral device	Generic term for engineering tools and GOTs
GOT	Generic term for Mitsubishi Electric Graphic Operation Terminal GOT1000 and GOT2000 series
■Software packages	
Engineering tool	The product name of the software package for the MELSEC programmable controllers
GX Works3	The product name of the software package, SWnDND-GXW3, for the MELSEC programmable controllers (The 'n' represents a version.)

1 DESCRIPTION

FX5-4LC temperature control module equipped with 4 channel input (thermocouples, resistance thermometer and micro voltage input), 4 points output (open collector transistor) and 4 points current sensor input can perform temperature control. Further, PID control is also possible using voltage/current inputs and voltage/current outputs by connecting a separate analog expansion adapter and intelligent function module.

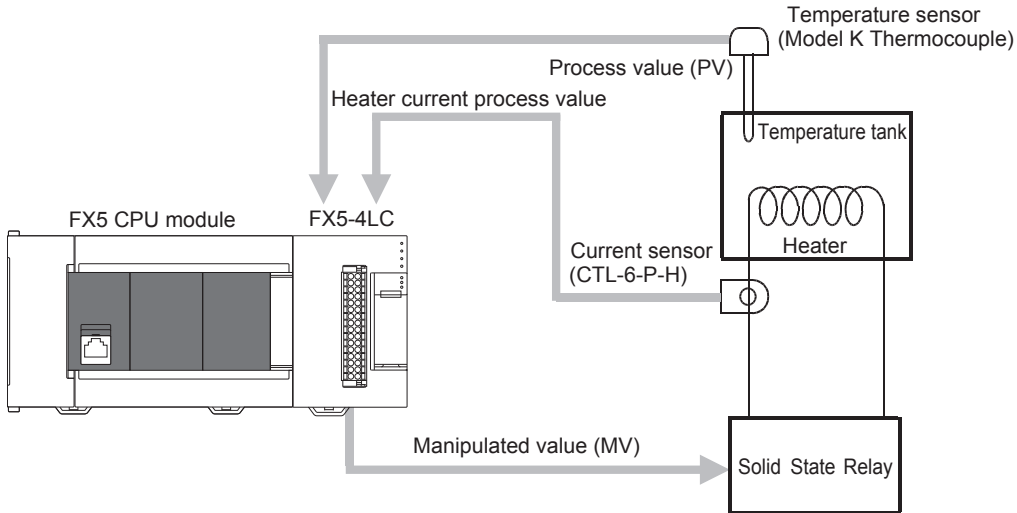

2 SPECIFICATIONS

This chapter describes the temperature control module specifications.

2.1 General Specifications

The general specifications other than below are the same as those for the CPU module to be connected.

For general specifications, refer to the following.

📖 MELSEC iQ-F FX5UJ User's Manual (Hardware)

📖 MELSEC iQ-F FX5U User's Manual (Hardware)

📖 MELSEC iQ-F FX5UC User's Manual (Hardware)

Items	Specifications	
Dielectric withstand voltage	500 V AC for 1 minute	Between all terminals and ground terminal
Insulation resistance	10 MΩ or higher by 500 V DC insulation resistance tester	

2.2 Power Supply Specifications

The following table lists the power supply specifications.

Items	Specifications	
External power supply	Power supply voltage	24 V DC +20%, -15%
	Allowable instantaneous power failure time	Operation continues when the instantaneous power failure is shorter than 5 ms.
	Current consumption	25 mA
Internal power supply	Power supply voltage	5 V DC
	Current consumption	140 mA

2.3 Performance Specifications

The following table lists the performance specifications.

Items	Specifications
Control method	Two-position control, PID control, Heating/cooling PID control, Cascade control
Control operation period	250 ms/4ch
Measured temperature range	📖 Page 19 Measured temperature range
Heater disconnection detection	Alert is detected (Variable within range from 0.0 to 100.0 A by GX Works3.)
Operation mode	0: Not used 1: Monitor only 2: Monitor + alert 3: Monitor + alert + control (Selected by GX Works3)
Insulation method	<ul style="list-style-type: none"> The photocoupler is used to insulate the analog input area and transistor output area from the PLC. The DC/DC converter is used to insulate the power supply from the analog input area and transistor output area. Channels are insulated from each other.
Number of occupied I/O points	8 points
Applicable CPU module	<ul style="list-style-type: none"> FX5UJ CPU module (From the first) FX5U CPU module (Ver.1.050 or later) FX5UC CPU module*1 (Ver.1.050 or later)
Applicable engineering tool	<ul style="list-style-type: none"> FX5UJ CPU module: GX Works3 (Ver.1.060N or later) FX5U/FX5UC CPU module: GX Works3 (Ver.1.035M or later)

*1 FX5-CNV-IFC or FX5-C1PS-5V is necessary to connect FX5-4LC to the FX5UC CPU module.

Input specifications

Items	Specifications	
Number of input points	4 points	
Input type ^{*1}	Thermocouple	K, J, R, S, E, T, B, N JIS C 1602-1995 PL II, W5Re/W26Re, U, L
	Resistance thermometer	3-wire type Pt100 JIS C 1604-1997 (New JIS) 3-wire type JPt100 JIS C 1604-1981 (obsolete JIS) 2-wire type/3-wire type Pt1000 JIS C 1604-2013
	Micro voltage input	
Measurement precision	☞ Page 17 Measurement precision	
Cold contact temperature compensation error	When ambient temperature is 0 to 55°C	Within ±1.0°C However, within ±2.0°C while input value is -150 to -100°C / within ±3.0°C while input value is -200 to -150°C
	When ambient temperature is -20 to 0°C	Within ±1.8°C However, within ±3.6°C while input value is -150 to -100°C / within ±5.4°C while input value is -200 to -150°C
Resolution	0.1°C (0.1°F), 1.0°C (1.0°F), 0.5 μV, or 5.0 μV Varies depending on input range of used sensors.	
Sampling period	250 ms/4ch	
Effect of external resistance (When thermocouple is used)	Approx. 0.125 μV/Ω	
Effect of input lead wire resistance (When resistance thermometer is used)	3-wire type	Approx. 0.03%/Ω of full scale. 10 Ω or less per 1-wire
	2-wire type	Approx. 0.04%/Ω of full scale. 7.5 Ω or less per 1-wire
Input impedance	1 MΩ or more	
Sensor current	Approx. 0.20 mA (When resistance thermometer is used)	
Operation when input is disconnected/Operation when input is short-circuited	Upscale/downscale (When resistance thermometer is used)	

*1 A different input can be selected for each channel.

Measurement precision

Measurement precision is as described below. However, cold contact temperature compensation errors are not included in the thermocouple precision. For cold contact temperature compensation errors, refer to ☞ Page 17 Input specifications. Further, the input value rounds up the minimum resolution for the measurement precision described below.

If the ambient temperature is 25°C±5°C

Input type	Input range	Measurement precision
K, J, E, T, PL II, U, L	Less than -100°C	±3.0°C ±1 digit
	-100°C to less than +500°C	±1.5°C ±1 digit
	500°C or more	± (0.3% of display value) ±1 digit
R, S, N, W5Re/W26Re	Less than 1000°C	±3.0°C ±1 digit
	1000°C or more	± (0.3% of display value) ±1 digit
B	Less than 400°C	±70°C ±1 digit
	400°C to less than 1000°C	±3°C ±1 digit
	1000°C or more	± (0.3% of display value) ±1 digit
Pt100, JPt100, Pt1000	Less than 200°C	±0.6°C ±1 digit
	200°C or more	± (0.3% of display value) ±1 digit
Micro voltage input	± (0.3% of span) ±1 digit	

If the ambient temperature is 0°C to 55°C

Input type	Input range	Measurement precision
K, J, E, T, PL II, U, L	Less than -100°C	±7.0°C ±1 digit
	-100°C to less than +500°C	±3.5°C ±1 digit
	500°C or more	± (0.7% of display value) ±1 digit
R, S, N, W5Re/W26Re	Less than 1000°C	±7.0°C ±1 digit
	1000°C or more	± (0.7% of display value) ±1 digit
B	Less than 400°C	±140°C ±1 digit
	400°C to less than 1000°C	±7°C ±1 digit
	1000°C or more	± (0.7% of display value) ±1 digit
Pt100, JPt100, Pt1000	Less than 200°C	±1.4°C ±1 digit
	200°C or more	± (0.7% of display value) ±1 digit
Micro voltage input	± (0.7% of span) ±1 digit	

If the ambient temperature is -20°C to 0°C

Input type	Input range	Measurement precision
K, J, E, T, PL II, U, L	Less than -100°C	±9.0°C ±1 digit
	-100°C to less than +500°C	±4.5°C ±1 digit
	500°C or more	± (0.9% of display value) ±1 digit
R, S, N, W5Re/W26Re	Less than 1000°C	±9.0°C ±1 digit
	1000°C or more	± (0.9% of display value) ±1 digit
B	Less than 400°C	±180°C ±1 digit
	400°C to less than 1000°C	±9°C ±1 digit
	1000°C or more	± (0.9% of display value) ±1 digit
Pt100, JPt100, Pt1000	Less than 200°C	±1.8°C ±1 digit
	200°C or more	± (0.9% of display value) ±1 digit
Micro voltage input	± (0.9% of span) ±1 digit	

Current detector (CT) input specifications

Items	Specifications	
Number of input points	4 points	
Current sensor	When using this product in the United States or Canada, use current sensors with UL/cUL Listed and/or CSA certified such as XOBA and XOBA7. When using current sensors in countries other than the above, we recommend the following. CTL-12-S36-8, CTL-12-S36-10, CTL-12-S56-10, CTL-12L-8, CTL-6-P, CTL-6-P-H, CTL-6-S-H (manufactured by U.R.D. Co., Ltd.)	
Allowable input current	0 to 182.2 mArms	
Heater current process value	When CTL-12-S36-8 is used	0.0 to 100.0 A
	When CTL-12-S36-10 is used	0.0 to 100.0 A
	When CTL-12-S56-10 is used	0.0 to 100.0 A
	When CTL-12-8 is used	0.0 to 100.0 A
	When CTL-6-P is used	0.0 to 30.0 A
	When CTL-6-P-H is used	0.0 to 30.0 A
	When CTL-6-S-H is used	0.0 to 30.0 A
Measurement precision	Larger one between ±5% of input value and ±2 A (Excluding precision of current sensor)	
Sampling period	0.5 sec.	

Process values

To stabilize the measurement precision, warm-up (supply power) the system for 30 minutes or more after power-on.

Measured temperature range

Items	Specifications
K	-200 to +1300°C (-100 to +2400°F)
J	-200 to +1200°C (-100 to +2100°F)
T	-200 to +400°C (-300 to +700°F)
S	0 to 1700°C (0 to 3200°F)
R	0 to 1700°C (0 to 3200°F)
E	-200 to +1000°C (0 to 1800°F)
B	0 to 1800°C (0 to 3000°F)
N	0 to 1300°C (0 to 2300°F)
PL II	0 to 1200°C (0 to 2300°F)
W5Re/W26Re	0 to 2300°C (0 to 3000°F)
U	-200 to +600°C (-300 to +700°F)
L	0 to 900°C (0 to 1600°F)
Micro voltage input	DC0 to 10 mV, DC0 to 100 mV
Pt100 (3-wire type)	-200 to +600°C (-300 to +1100°F)
JPt100 (3-wire type)	-200 to +500°C (-300 to +900°F)
Pt1000 (2-wire type/3-wire type)	-200.0 to +650.0°C (-328 to +1184°F)

Output specifications

Items	Specifications
Number of output points	4 points
Output method	NPN open collector transistor output
Rated load voltage	5 to 24 V DC
Maximum load voltage	30 V DC or less
Maximum load current	100 mA
Leak current in OFF status	0.1 mA or less
ON voltage	1.5 V (When maximum load current)
Control output cycle	0.5 to 100.0 sec.

2.4 Part Names

This section describes the names of each part of the temperature control module.

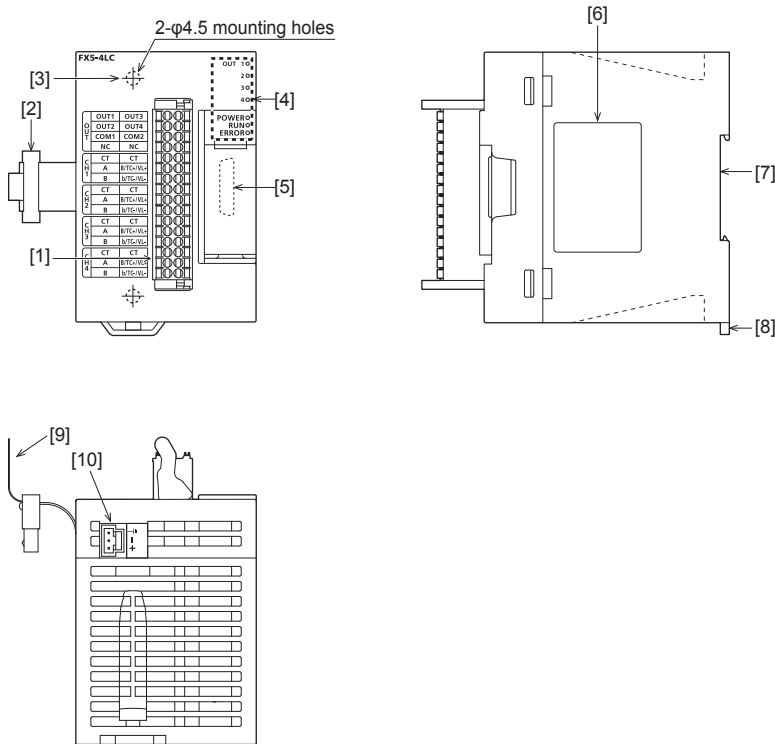

No.	Name	Description
[1]	Terminal block (Spring clamp terminal block)	Used in temperature sensor and current sensor (CT) inputs, and transistor outputs.
[2]	Expansion cable	Cable for connecting the module when adding the temperature control module.
[3]	Direct mounting hole	Screw holes (2- ϕ 4.5, mounting screw: M4 screw) for direct installation.
[4]	Operations status display LEDs	Indicates the operating status of the module. (☞ Page 20 LED display)
[5]	Extension connector	Connector for connecting the extension cable of an extension module.
[6]	Name plate	The product model name and manufacturer's serial number are shown.
[7]	DIN rail mounting groove	The module can be installed on DIN46277 rail (35 mm wide).
[8]	DIN rail mounting hook	Hook for mounting the module on a DIN rail of DIN46277 (35 mm wide).
[9]	Pullout tab	They are used when drawing out an extension cable.
[10]	Power connector	Connector for connecting the power cable. (☞ Page 73 Power Supply Wiring)

LED display

The following table lists the LED display.

LED display	LED color	Description
POWER	Green	Indicates the power supply status. ON: Power ON OFF: Power OFF or module failure
RUN	Green	Indicates the operations status. ON: Normal operation OFF: Error
ERROR	Red	Indicates the error status. ON: Minor error or major error Flashing: Moderate error or major error OFF: Normal operation
OUT1 to OUT4	Green	Indicates the output status. ON: OUT1 to OUT4 output on ON: OUT1 to OUT4 output off

3 PROCEDURES BEFORE OPERATION

This chapter describes the procedures before operation.

1. Checking the temperature control module specifications

Check the temperature control module specifications. ( Page 16 SPECIFICATIONS)

2. Mounting the temperature control module

Mount the temperature control module to the FX5 CPU module. For details, refer to the following.

 MELSEC iQ-F FX5UJ User's Manual (Hardware)

 MELSEC iQ-F FX5U User's Manual (Hardware)

 MELSEC iQ-F FX5UC User's Manual (Hardware)

3. Wiring

Wire the external devices to the temperature control module.

4. Adding modules

Add temperature controllers to the module configuration using GX Works3.

Point

When adding a temperature control module, FX3 allocation mode is usable if a module with the suffix "(FX3)" after its name is selected.

- FX5-4LC: Normal mode
- FX5-4LC (FX3): FX3 allocation mode

If the mode is changed, an error occurs at startup, and setting value backup is required.

For details on the buffer memory data backup function, refer to the following.

 Page 64 Buffer Memory Data Backup Function

5. Parameter settings

Set the temperature control module parameters using GX Works3.

6. Implementing auto tuning

If implementing auto tuning, set PID using the auto tuning function.

7. Programming

Create the program.

8. Warm-up operations

Implement warm-up for approx. 30 mins. before starting operations.

4 FUNCTION

This chapter describes the function details of the temperature control module.

For details on the buffer memory, refer to the following.

 Page 117 Details of buffer memory addresses

Point

This chapter describes the buffer memory for CH1.

For details on the buffer memory addresses for CH2 or later, refer to the following.

 Page 99 List of buffer memory addresses

4.1 Functions List

The following table lists the temperature control module functions.

Items		Description	Usability		Reference
			Standard PID control	Heating/cooling PID control	
Control mode selection function		Use this function to select the control mode from among those described below. <ul style="list-style-type: none"> Standard PID control Heating/cooling PID control 	<input type="radio"/>	<input type="radio"/>	Page 24
Control method	Two-position control	Control methods can be achieved by setting a proportional band (P), integral time (I), and derivative time (D).	<input type="radio"/>	<input type="radio"/>	Page 26
	P control		<input type="radio"/>	<input type="radio"/>	
	PI control		<input type="radio"/>	<input type="radio"/>	
	PD control		<input type="radio"/>	<input type="radio"/>	
	PID control		<input type="radio"/>	<input type="radio"/>	
Manual control		A manipulated value (MV) can be set manually by users without being automatically calculated by the PID control.	<input type="radio"/>	<input checked="" type="checkbox"/>	Page 30
Balance bumpless function		This function prevents sudden outputs change during AUTO↔MAN mode switching.	<input type="radio"/>	<input checked="" type="checkbox"/>	Page 31
RFB limiter function		When the deviation (E) continues for a long period of time, this function prevents the PID operation results (manipulated value (MV)) calculated by integral actions from exceeding the effective range of the manipulated value (MV).	<input type="radio"/>	<input type="radio"/>	Page 31
Simple two-degree-of-freedom		In addition to the PID control, this function selects a suitable response speed for the set value (SV) change from three levels to simply achieve the two-degree-of-freedom PID control.	<input type="radio"/>	<input type="radio"/>	Page 32
Normal operation/reverse operation selection function		Select whether or not to implement a PID operation with a normal operation or a reverse operation.	<input type="radio"/>	<input checked="" type="checkbox"/>	Page 32
Proportional band setting function		This function can set the proportional bands (P) for heating and cooling individually.	<input checked="" type="checkbox"/>	<input type="radio"/>	Page 33
Overlap/dead band function		The temperature where the cooling control output starts can be shifted using this function and, consequently, whether control stability is prioritized or energy saving is prioritized can be selected.	<input checked="" type="checkbox"/>	<input type="radio"/>	Page 34
Cooling method setting function		During auto tuning, an auto tuning operational expression is automatically selected depending on a selected cooling method and an operation starts.	<input checked="" type="checkbox"/>	<input type="radio"/>	Page 35
Auto tuning function		The temperature control module automatically sets the best PID constants.	<input type="radio"/>	<input type="radio"/>	Page 36
AT bias function		This function changes the AT point by applying bias to the set value (SV) during auto tuning.	<input type="radio"/>	<input type="radio"/>	Page 40

Items	Description	Usability		Reference
		Standard PID control	Heating/cooling PID control	
Startup tuning function	The temperature control module constantly monitors the control state, so when the control system is oscillatory just after the control start, owing to the set value (SV) change or fluctuation of characteristics of a controlled object, this function allows PID constants to be automatically changed.	○	×	Page 41
Operation mode	Select from not used, monitor only, monitor + alert, and monitor + alert + control for each channel.	○	○	Page 43
Cascade control	Monitors the target control temperature using the master, and corrects slave set values according to the deviation between the set value (SV) and the actual value. Controlled devices are adjusted by the slaves and, as a result, control of the target control temperature reaches the set value.	○	×	Page 44
SV tracking function	This function prevents sudden output changes in the slave channel when turning OFF cascade control.	○	×	Page 46
Settings limiter function	This function limits the settings range of the set value (SV).	○	○	Page 46
Setting change rate limiter setting function	Select whether to set individually or en bloc the setting variation rate limiters for temperature rise and fall.	○	○	Page 47
Input type selection function	Select either resistance temperature detector or low voltage as the input sensor type.	○	○	Page 47
Sensor correction function	When there is an error between the temperature process value (PV) and actual temperature due to measurement conditions, this function corrects the error. Corrects the ratio to the full scale of the set input range as the error correction value.	○	○	Page 48
Primary delay digital filter	By setting the primary delay digital filter, a temperature process value (PV) with smoothed transient noise can be output.	○	○	Page 49
Temperature rise judgment function	This function judges whether the process value (PV) is within the temperature rise judgment range during temperature sensor sampling.	○	○	Page 50
External (other analog module) I/O function	This function enables inputs and outputs using another analog module on the system.	○	○	Page 50
Output limiter function	This function limits the upper and lower limits of the manipulated value (MV).	○	○	Page 51
Output change ratio limiter function	The Output change ratio limiter functions to limit the amount of change in the manipulated value (MV) per unit time. Outputs to control targets that dislike output mutations can be limited using the set output change amount.	○	×	Page 52
Control output flag	Turns ON and OFF the control outputs monitor.	○	○	Page 52
Transistor outputs selection	This function selects the transistor output functions built into the temperature control module.	○	○	Page 53
Alert function	This function sends an alert when a temperature process value (PV) or deviation (E) meets the condition set in advance.	○	○	Page 54
Loop disconnection detection function	This function measures the current flowing to the main heater circuit, and detects disconnections.	○	×	Page 61
Loop disconnection detection dead band function	This function sets the on-alert area centering on the set value (SV).	○	×	Page 62
Heater disconnection detection function	This function measures the current flowing to the main heater circuit, and detects disconnections.	○	○	Page 63
Output OFF-time current error detection function	This function detects errors when the transistor outputs are OFF.	○	○	Page 63
Buffer memory data backup function	This function backs up the set values in the buffer memory to non-volatile memory.	○	○	Page 64
Default function	This function sets the buffer memory to the default values.	○	○	Page 65

Items	Description	Usability		Reference
		Standard PID control	Heating/cooling PID control	
Error history function	This function stores a maximum of 16 errors and alarms that occurred in the temperature control module to buffer memory as a history.	<input type="radio"/>	<input type="radio"/>	Page 65
FX3 allocation mode function	The temperature control module buffer memory addresses can be arranged in the same way as for FX3U-4LC.	<input type="radio"/>	<input type="radio"/>	Page 68

4.2 Control Mode Selection Function

This function selects the I/Os (external or internal) to be used as the control type (standard PID control for heating and cooling PID control) for each control group.

The control groups are divided as described below.

- Control group 1: CH1 and CH2
- Control group 2: CH3 and CH4

Standard PID control, heating and cooling PID control

There are two types of control modes in the temperature control module: Standard PID control and heating-cooling PID control.

■Standard PID control

This control method attempts to acquire stable control results by setting the constants for P (proportional band) I (integral time) and D (derivative time).

"Response to noise" worsens for this PID control if the PID constants are set to improve "Response to settings". Further, "Response to settings" worsens if the PID constants are set to improve "Response to noise".

The temperature control module can be used to select "Fast", "Normal", and "Slow" using the control response parameters for the shape of the "Response to settings" with the PID constants to improve "Response to noise" unchanged.

■Heating/cooling PID control

Heating and cooling PID controls are the control methods that operate the outputs for both the heating and cooling control systems.

In heating, the manipulated value (MV) operation decreases (reverse operation) according to increases in the process value (PV), and in cooling, the manipulated value (MV) operation increased (normal operation) according to increases in the process value (PV).

Set cooling and heating PID constants individually for proportional band (P) cooling and heating. Integral time (I) and derivative time (D) are common set values for both heating and cooling.

Consequently, the temperature control module implements calculations using the four PID constants of heating proportional band, cooling proportional band, integral time, and derivative time.

Further, it is possible to establish dead bands, and implement overlap and outputs, using the heating and cooling control switching points.

Selectable control modes

A control mode can be selected from the modes described below. Select a control mode in "Control mode selection" of "Base Setting".

Control mode	Control types	Input	Output
0	Standard PID control	Internal	Internal
1	Standard PID control	External	Internal
2	Standard PID control	Internal	External
3	Standard PID control	External	External
4	Heating/cooling PID control	Internal	Internal
5	Heating/cooling PID control	External	Internal
6	Heating/cooling PID control	Internal	External
7	Heating/cooling PID control	External	External

If Internal is selected in either inputs or outputs, control is implemented using the I/O built into the temperature control module. If External is selected in either inputs or outputs, control is implemented using another analog module connected to the CPU module.

■If external inputs are selected

If external inputs are selected, the parameters are as described below.

- Input range setting

The internal span is from "external input range upper limit" to "external input range lower limit".

The input range is from "external input range lower limit" to "external input range upper limit".

- Settings limiter

The settings range for the upper limit setting limiter is from "lower limit setting limiter value +1" to "External input range upper limit".

The settings range for the lower limit setting limiter is from "external input range lower limit" to "upper limit setting limiter -1".

- Set value settings

The set value settings are from "lower limit setting limiter" to "upper limit setting limiter".

- Input errors

If a value at or greater than "external input range upper limit +5%/Input span" is set in the external input value, an (upper limit) input error occurs, and an event (Un\G429, b0) turns ON.

If a value at or less than "external input range lower limit -5%/Input span" is set in the external input value, a (lower limit) input error occurs, and an event (Un\G429, b1) turns ON.

■If external outputs are selected

If external outputs are selected, the values that scale the control output value (from the external output range lower limit to the external output range upper limit) are written to the manipulated value (MV) for external (other analog module) outputs, Manipulated value for heating (MVh) for external (other analog module) outputs, and Manipulated value for cooling (MVc) for external (other analog module) outputs, regardless of the control mode switching settings.

4.3 Control Method

The following control methods can be achieved by setting a proportional band (P), integral time (I), and derivative time (D).

- Two-position control
- P control
- PI control
- PD control
- PID control

Two-position control

Two-position control is a control method that uses the 0% manipulated value (MV) and 100% manipulated value (MV). Turning ON and OFF the manipulated value (MV) repeatedly makes the temperature process value come close to the set value (SV), and the temperature is kept constant.



By the setting in "Adjustment sensitivity (dead band) setting" of "Application Setting", the chattering of transistor outputs under two-position control can be prevented. Set the set value (SV).

Standard PID control

The module operates as described below outside the setting range of "Adjustment sensitivity (dead band) setting" in "Application Setting".

Condition	Transistor output status
The temperature process value (PV) is below the lower limit of the adjustment sensitivity (dead band)	ON
The temperature process value (PV) is above the upper limit of the adjustment sensitivity (dead band)	OFF

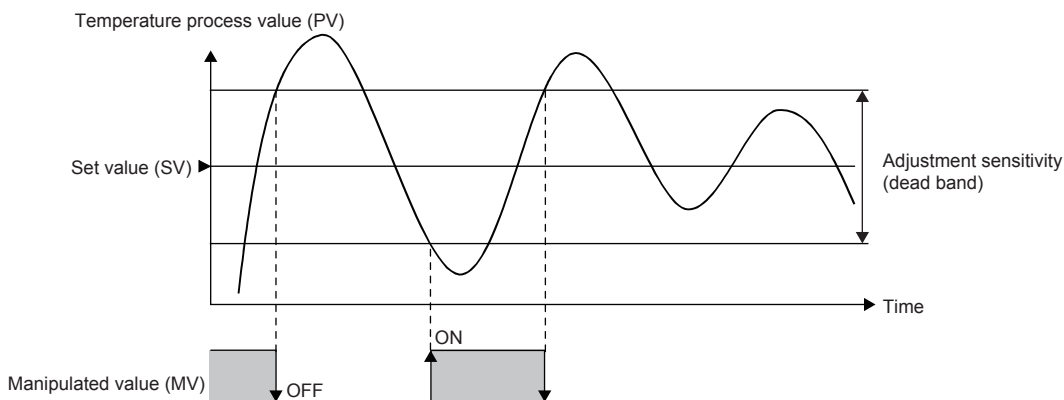

■Heating-cooling PID control

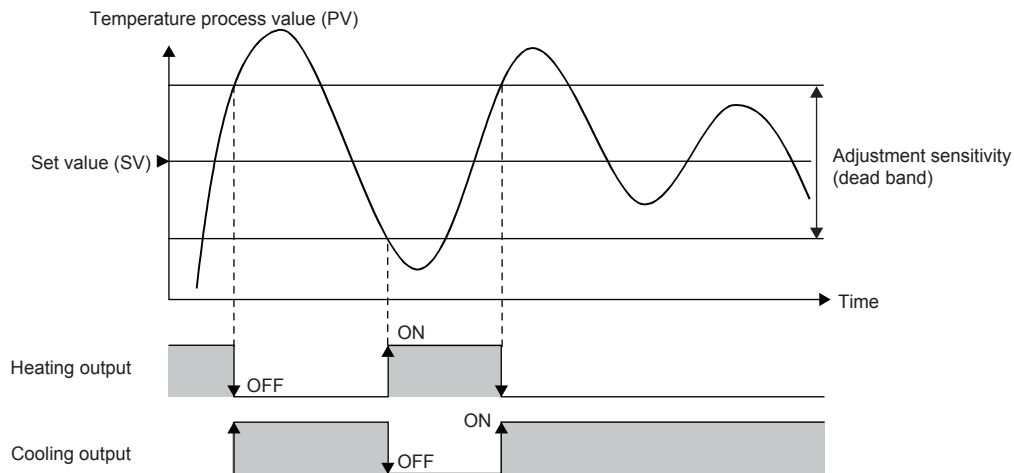

The module operates as described below outside the setting range of "Adjustment sensitivity (dead band) setting" in "Application Setting".

Condition	Heating transistor output status	Cooling transistor output status
The temperature process value (PV) is below the lower limit of the adjustment sensitivity (dead band)	ON	OFF
The temperature process value (PV) is above the upper limit of the adjustment sensitivity (dead band)	OFF	ON



■Setting method

Set 0 (0°C (°F)) in the following buffer memory areas.

- 'CH1 Proportional band (P) setting' (Un\G431) ( Page 135 CH1 Proportional band (P) setting)
- 'CH1 Heating proportional band (Ph) setting' (Un\G431) ( Page 136 CH1 Heating proportional band (Ph) setting)

P control

P control is a control method in which the manipulated value (MV) is determined proportional to the deviation (E) between the temperature process value (PV) and set value (SV).

■Standard PID control

The manipulated value (MV) is 50% in the following conditions.

- Temperature process value (PV) = Set value (SV)

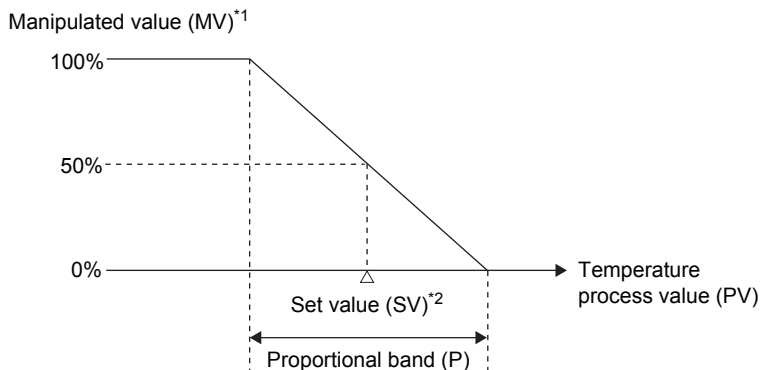

*1 A value to be actually output is within the output limiter range set in "Upper limit output limiter" and "Lower limit output limiter" of "Limiter setting" in "Application Setting".

*2 The set value (SV) is the center of the proportional band (P).

■Heating-cooling PID control

The manipulated value for heating (MVh) and the manipulated value for cooling (MVc) are both 0% in the following conditions.

- If the overlap/dead band set value is 0 using temperature process value (PV)= set value (SV)

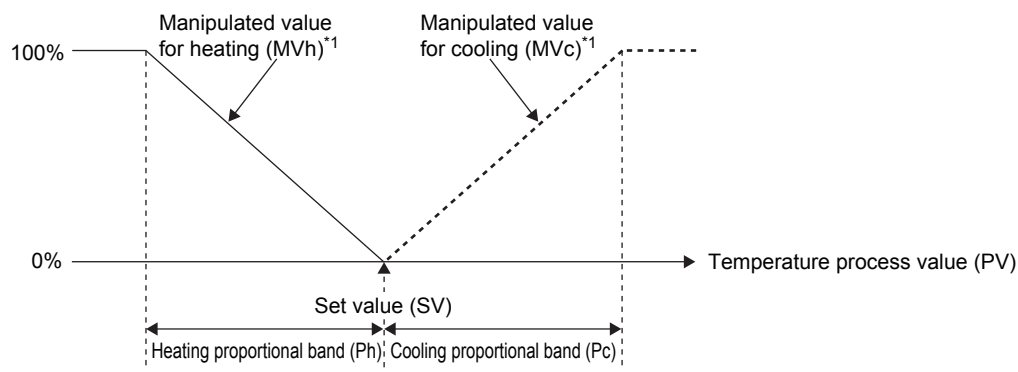

*1 A value to be actually output is within the output limiter range set in "Upper limit output limiter" and "Lower limit output limiter" of "Limiter setting" in "Application Setting". (Page 78 Application Setting)

■Setting method

Make the settings as described below.

- 'CH1 Integral time (I) setting' (Un\G432): 0 to 0 (s) (Page 136 CH1 Integral time (I) setting)
- 'CH1 Derivative time (D) setting' (Un\G433): 0 to 0 (s) (Page 137 CH1 Derivative time (D) setting)

PI control

PI control is a control method in which derivative elements are added to P control, and thereby corrects an offset (remaining deviation) that remains when the temperature is stable. By setting the integral time (I) properly, the temperature process value (PV) matches the set value (SV).

■Setting method

Make the settings as described below.

- 'CH1 Derivative time (D) setting' (Un\G433): 0 to 0 (s) (Page 137 CH1 Derivative time (D) setting)

PD control

PD control is a control method in which the derivative time (D) is set in addition to P control. The control mechanism is the same as P control.

■Setting method

Make the settings as described below.



- 'CH1 Integral time (I) setting' (Un\G432): 0 to 0 (s) ( Page 136 CH1 Integral time (I) setting)

PID control

PID control is a control method in which derivative elements are added to PI control, and thereby the temperature shifts to a stable status in a short period of time even when a drastic change has occurred. By setting the derivative time (D) properly, the controlled object shifts to a stable status in a short period of time.





■Settings method (If using standard PID control)

Make the settings as described below.

- 'CH1 Proportional band (P) setting' (Un\G431): Any value ( Page 135 CH1 Proportional band (P) setting)
- 'CH1 Integral time (I) setting' (Un\G432): Any value ( Page 136 CH1 Integral time (I) setting)
- 'CH1 Derivative time (D) setting' (Un\G433): Any value ( Page 137 CH1 Derivative time (D) setting)

■Settings method (If using heating-cooling PID control)

Make the settings as described below.

- 'CH1 Heating proportional band (Ph) setting' (Un\G431): Any value ( Page 136 CH1 Heating proportional band (Ph) setting)
- 'CH1 Cooling proportional band (Pc) setting' (Un\G439): Any value ( Page 140 CH1 Cooling proportional band (Pc) setting)
- 'CH1 Integral time (I) setting' (Un\G432): Any value ( Page 136 CH1 Integral time (I) setting)
- 'CH1 Derivative time (D) setting' (Un\G433): Any value ( Page 137 CH1 Derivative time (D) setting)

Parameters related to control methods

The following table shows the parameters related to each control method.

Parameter	Setting range				
	Two-position control	P control	PD control	PI control	PID control
Input range setting	<ul style="list-style-type: none"> • Thermocouple: 0 to 35 • Platinum resistance thermometer: 36 to 45 • Micro voltage input: 46 to 47 				
Set value (SV) setting	Set a value within the temperature measuring range of the set input range.				
Adjustment sensitivity (dead band) setting	1 to 100 (0.1 to 10.0%)	The set value is ignored.			
Upper limit output limiter, lower limit output limiter (standard PID control only)	The set value is ignored.	-50 to 1050 (-5.0 to 105.0%)			
Upper limit output limiter, cooling upper limit output limiter (heating-cooling PID control only)	The set value is ignored.	0 to 1050 (0.0 to 105.0%)			
Output change ratio limiter	The set value is ignored.	1 to 1000 (1 to 100.0%/s)			
Control output cycle setting	The set value is ignored.	<ul style="list-style-type: none"> • Settings range: 5 to 1000 (0.5 to 100.0 s) • Default value: 300 (30.0 s) 			
Cooling control output cycle setting (heating-cooling PID control only)	The set value is ignored.	<ul style="list-style-type: none"> • Settings range: 5 to 1000 (0.5 to 100.0 s) • Default value: 300 (30.0 s) 			
Overlap/dead band setting	-100 to 100 (-10.0 to 10.0%)				



Buffer memory areas related to control methods

The following table shows the buffer memory areas related to each control method.

Buffer memory name	Buffer memory address	Setting range				
		Two-position control	P control	PD control	P control	PID control
CH1 Cooling proportional band (P) setting, CH1 Heating proportional band (Ph) setting (If using normal mode)	431	Fix the setting to 0.	0 to 10000 (0.0 to 1000.0% span)			
CH1 Cooling proportional band (Pc) setting (If using normal mode)	439					
CH1 Integral time (I) setting (If using normal mode)	432	The set value is ignored.	Fix the setting to 0.		1 to 3600(s)	
CH1 Differential time (D) setting (If using normal mode)	433	The set value is ignored.	Fix the setting to 0.	1 to 3600(s)	The set value is ignored.	1 to 3600(s)

Point

The temperature control module automatically sets optimum PID constants when the following functions are used.



- Auto Tuning Function ( Page 36 Auto Tuning Function)
- Startup tuning function ( Page 41 Startup Tuning Function)

4.4 Manual Control

A manipulated value (MV) can be set manually by users without being automatically calculated using the PID control.

Setting method

Configure the settings as described below.

1. Set 'CH1 AUTO/MAN mode shift' (Un\G518) to Manual (MAN) (1). ( Page 149 CH1 AUTO/MAN mode shift)
2. Set the manipulated value (MV) in 'CH1 Manual output setting' (Un\G519). ( Page 150 CH1 Manual output setting)

Setting range

The settings range is as described below.

- -50 to 1050 (-5.0 to 105.0%)

4.5 Balance Bumpless Function

Prevents overshoot due to sudden changes in the manipulated value (MV) when switching from AUTO mode to MAN mode (or from MAN mode to AUTO mode).

The balance bumpless from MAN mode to AUTO mode function is enabled only during PID control or PI control mode.

This function automatically operates during switching. No particular settings are required.

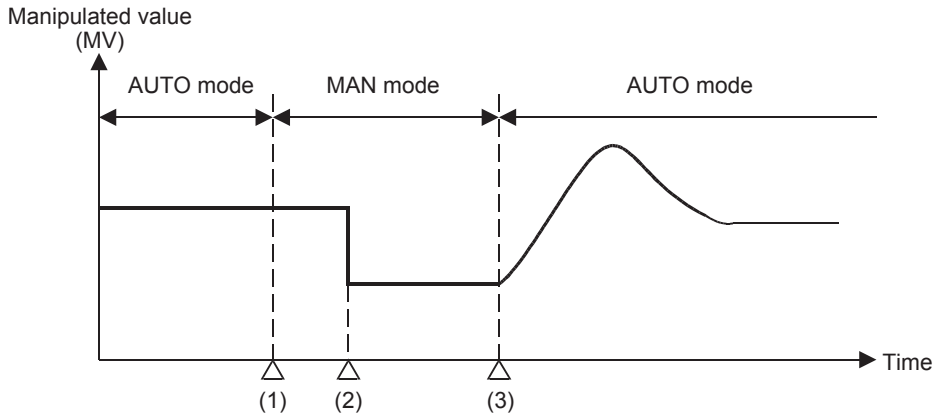

- (1) Switches from AUTO mode to MAN mode.
The manipulated value (MV) when switching to MAN mode obeys the manipulated value (MV) during AUTO mode.
- (2) Changes the manipulated value (MV) in MAN mode.
- (3) Switches from MAN mode to AUTO mode.
The manipulated value (MV) when switching to AUTO mode is the manipulated value (MV) calculated automatically for the set value (SV).

4.6 RFB Limiter Function

The RFB (reset feedback) function operates when deviation (E) continues for a long period of time.

When the deviation (E) continues for a long period of time, this function prevents the PID operation results (manipulated value (MV)) calculated by integral actions from exceeding the effective range of the manipulated value (MV).

This function automatically operates when the PID control is implemented. No particular settings are required.

Point

When a PID operation result is larger than the upper limit output limiter value, the temperature control module operates as described below.

- The RFB function levels the manipulated value (MV) to the upper limit output limiter value by feeding back an excess value to the integral value.

When a PID operation result is smaller than the lower limit output limiter value, the temperature control module operates as described below.

- The RFB function levels the manipulated value (MV) to the lower limit output limiter value by feeding back a required value to the integral value.

4.7 Simple Two-degree-of-freedom

In addition to the PID control, this function selects a suitable response speed for the set value (SV) change from three levels to simply achieve the two-degree-of-freedom PID control.

General PID controls are called one-degree-of freedom PID control. In the one-degree-of freedom PID control, when PID constants to improve "response to the change of the set value (SV)" have been set, "response to the noise" degrades. Conversely, when PID constants to improve "response to the noise" have been set, "response to the change of the set value (SV)" degrades.

Compared to one-degree-of freedom PID control, "response to the change of the set value (SV)" and "response to the noise" can be compatible with each other in the two-degree-of-freedom PID control.

Note that required parameter settings increase and it is difficult for PID constants to be automatically set by the auto tuning function for complete two-degree-of-freedom PID control. Consequently, the temperature control module operates in the simple two-degree-of-freedom PID control for which parameters are simplified.

In the PID control (simple two-degree-of-freedom) of the temperature control module, users can use PID constants making good "response to the noise" and the form of "response to change of the set value (SV)" can be selected from the following three types.

- Fast
- Normal
- Slow

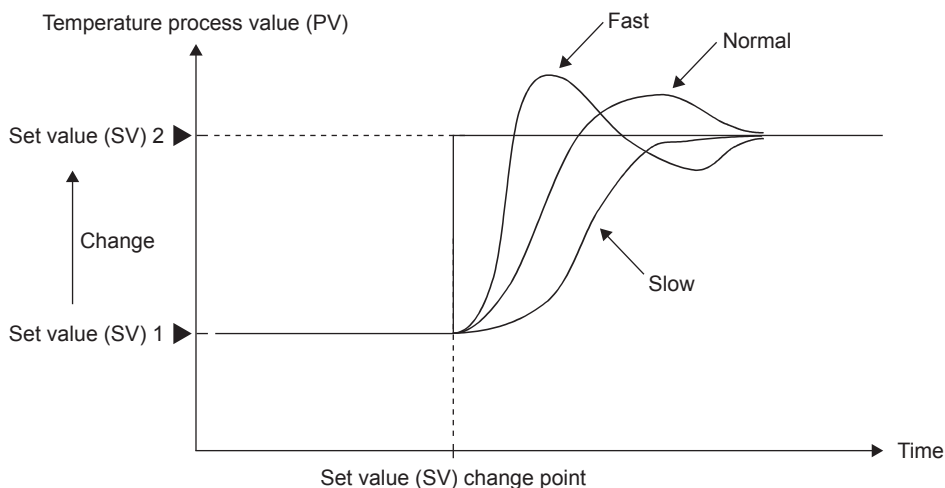

Setting method

Configure the settings as described below.

[Navigation window] ⇒ [Parameter] ⇒ Target module ⇒ [Module Parameter] ⇒ [Application Setting] ⇒ [Control basic parameters] ⇒ [Control Response Parameters]

4.8 Normal/Reverse Operation Selection Function

This function selects whether to implement normal or reverse operations during standard PID control.

This function can be used in all the control methods (two-position control, P control, PI control, PD control, and PID control).

(☞ Page 26 Control Method)

For details on the operation, refer to the following.

(☞ Page 167 Actions of the temperature control module)

Setting method

Configure the settings as described below.

[Navigation window] ⇒ [Parameter] ⇒ Target module ⇒ [Module Parameter] ⇒ [Application Setting] ⇒ [Normal Operation/Reverse Operation Setting]

4.9 Proportional Band Setting Function

This function can set the proportional bands (P) for heating and cooling individually. Different gradients can be set by using different proportional band (P) values in heating and cooling areas.

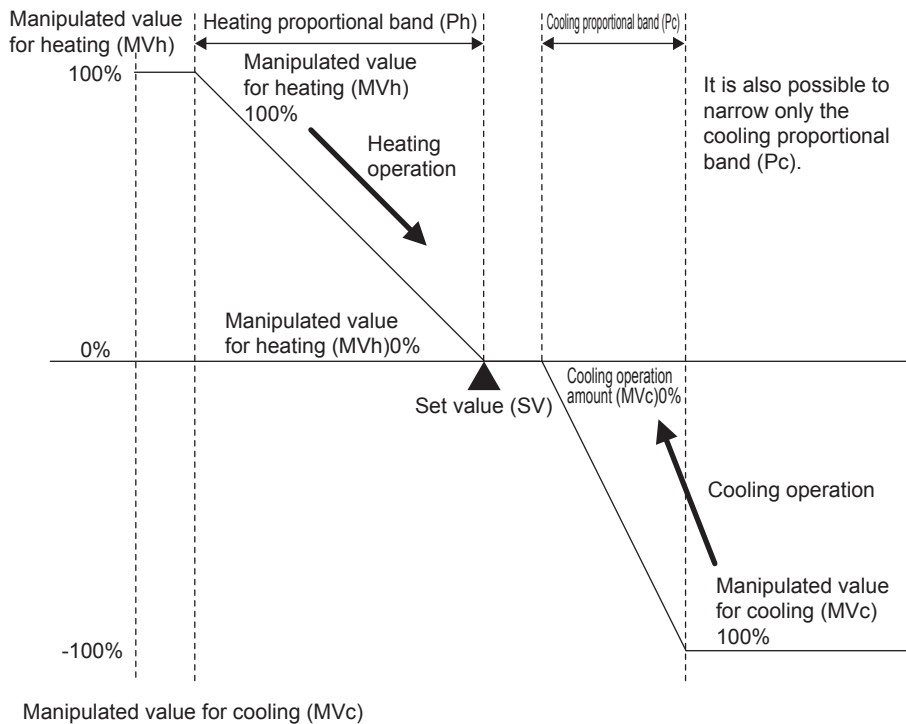

Setting method

■ For heating

Set in the following buffer memory area.

- 'CH1 Heating proportional band (Ph) setting' (Un\G431) (Page 136 CH1 Heating proportional band (Ph) setting)

■ For cooling

Set in the following buffer memory area.

- 'CH1 Cooling proportional band (Pc) setting' (Un\G439) (Page 140 CH1 Cooling proportional band (Pc) setting)

4.10 Overlap/dead Band Function

In the heating-cooling control, the temperature process value (PV) significantly changes due to a slight heating or cooling control output when the heat produced by a controlled object and natural cooling are being balanced. Consequently, an excessive output may be implemented.

The temperature where the cooling control output starts can be shifted using this function; consequently, whether control stability is prioritized or energy saving is prioritized can be selected.

Overlap

The overlap refers to the temperature area where both of heating control and cooling control are implemented. In the temperature area where both heating and cooling output overlap, both of the outputs negate each other, and so the control gain becomes moderate. Consequently, the variation amount in the temperature process value (PV) for the output becomes small, improving control stability.

If establishing an overlap area, set a negative value in the "Overlap/dead band setting".

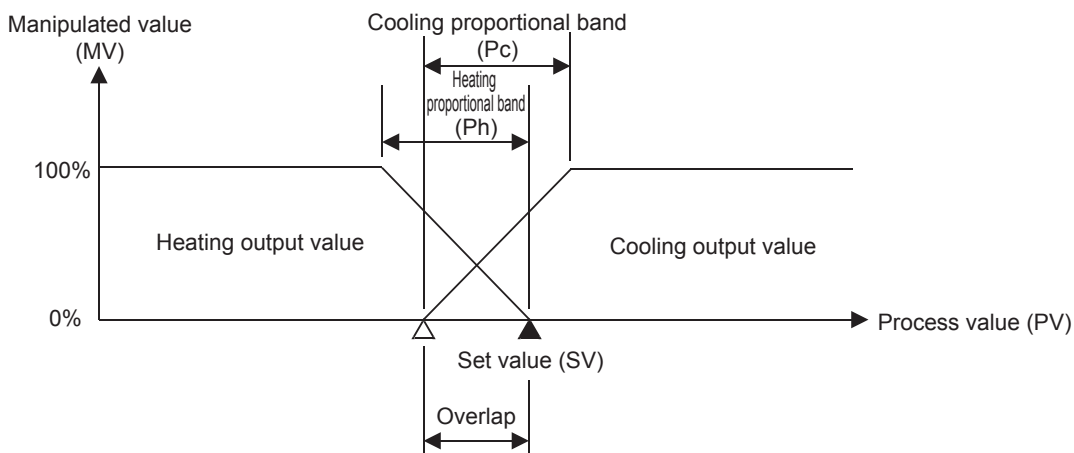

Dead band

The dead band refers to the temperature area where neither heating control output nor cooling control output is implemented. When the temperature process value (PV) is stable within this area, output is not implemented for a slight change in the temperature, resulting in energy saving.

If establishing a dead band area, set a positive value in the "Overlap/dead band setting".

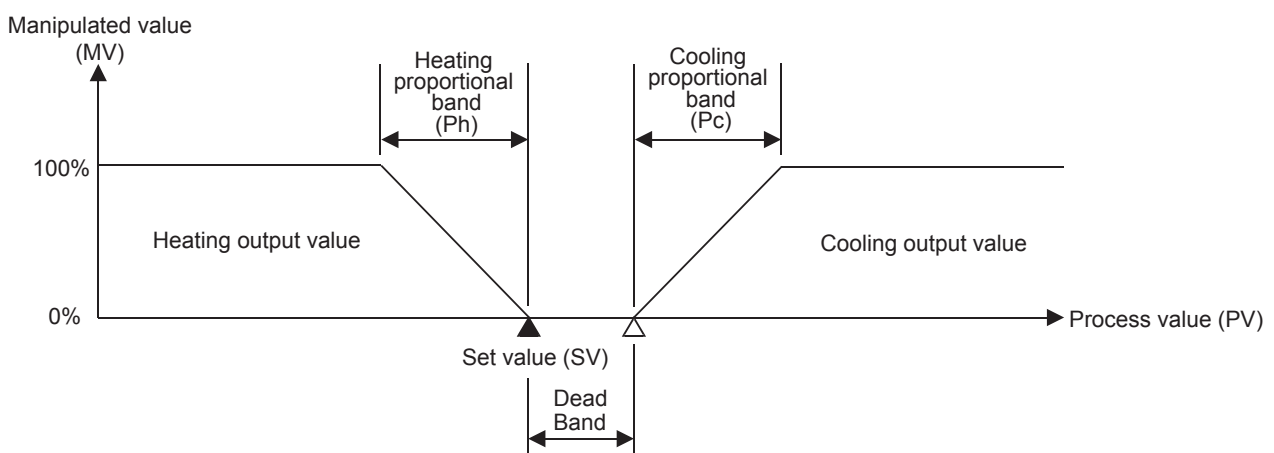

Setting method

Configure the settings as described below.

 [Navigation window] ⇒ [Parameter] ⇒ Target module ⇒ [Module Parameter] ⇒ [Application Setting] ⇒ [Heating/cooling control setting] ⇒ [Overlap/dead band setting]

4.11 Cooling Method Setting Function

This function switches the cooling method depending on whether the cooling device is air-cooling type, water-cooling type, or cooling gain linear type in the case of heating and cooling PID control. As the cooling characteristics between air cooling and water cooling are very different, it is possible to request PID constants for the device by setting the cooling method when implementing AT (auto tuning).

- Air-cooling type/water-cooling type

Uses an algorithm that presumes heating and cooling PID controls for plastic molding devices.

Good responsiveness and small set value response characteristics for over-travel amounts can be obtained even for devices that have cooling configurations with non-linear characteristics.

- Cooling gain linear type

Uses an algorithm that presumes applications without non-linear cooling performance, such as electronic coolers that use Peltier elements.

Point

During auto tuning implementation, PID constants are calculated and the auto tuning is implemented based on this setting. Consequently, more suitable PID constants can be calculated by the setting according to the cooling characteristics of the device. For details on the auto tuning function, refer to the following.

 Page 36 Auto Tuning Function

Setting method

Configure the settings as described below.

 [Navigation window] ⇒ [Parameter] ⇒ Target module ⇒ [Module Parameter] ⇒ [Application Setting] ⇒ [Heating/cooling control setting] ⇒ [Cooling method setting]

Point

- An operational expression of the auto tuning for the calculation of PID constants is determined based on this setting. Consequently, always configure this setting before implementing auto tuning.
- Air cooling and water cooling roughly indicate the level of the cooling ability. When a device is too cooled even though air cooling has been selected, set "1: Water cooling". When a device is less likely to be cooled even though water cooling has been selected, set "0: Air cooling".
- Generally, the ability of water cooling is higher than that of air cooling and cooling may be too strong when the same PID constants as the one for air cooling are used for water cooling. Consequently, it may take some time for control to stabilize. Consequently, the auto tuning calculates PID constants so that the PID constants of when "1: Water cooling" is set become larger than the ones of when "0: Air cooling" is set.

4.12 Auto Tuning Function

The temperature control module automatically sets the best PID constants. In the auto tuning, the control output is turned ON and OFF, and PID constants are calculated depending on the hunting cycle and amplitude that occur when overshoots and undershoots of the temperature process value (PV) to the set value (SV) are repeated.

Operations during auto tuning

The following operations are implemented if auto tuning during temperature rise.

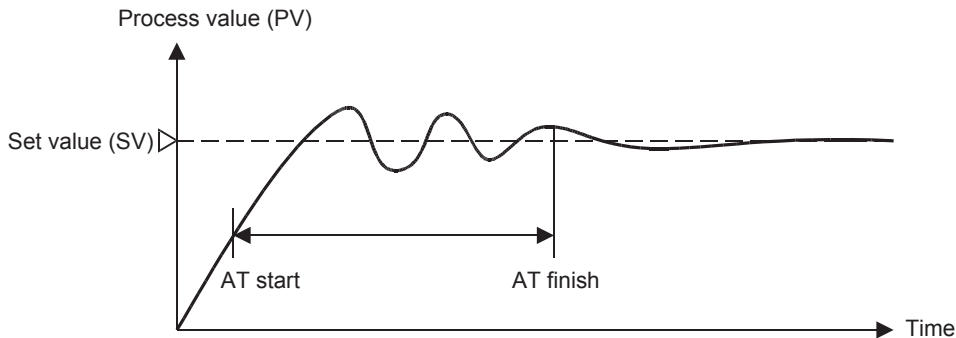

Settings related to the auto tuning

The auto tuning can be executed when the following setting have been configured. Configure the other settings to the values used for actual operations because actual control starts on completion of the auto tuning.

When "0" has been set for 'CH1 Proportional band (P) setting' (Un\G431) or 'CH1 Heating proportional band (Ph) setting' (Un\G431), auto tuning is not implemented.

- "Input range setting" of "Control basic parameters" in "Application Setting"
- "Set Value (SV) Setting" of "Control basic parameters" in "Application Setting"
- "Upper limit output limiter" of "Limiter setting" in "Application Setting"
- "Lower limit output limiter" of "Limiter setting" in "Application Setting"
- "Cooling upper limit output limiter" of "Heating/cooling control setting" in "Application Setting"
- "Output change ratio limiter" of "Limiter setting" in "Application Setting"
- "Sensor Correction Value Setting" in "Application Setting"
- "Control output cycle setting" of "Control basic parameters" in "Application Setting"
- "Cooling control output cycle setting" of "Heating/cooling control setting" in "Application Setting"
- "Primary Delay Digital Filter Setting" in "Application Setting"
- 'CH1 AUTO/MAN mode shift' (Un\G518)
- "AT Bias" of "Auto tuning setting" in "Application Setting"
- "Normal Operation/Reverse Operation Setting" in "Application Setting"

Storing the calculation values after auto tuning

After the completion of the auto tuning, calculation values are stored in the following buffer memory areas.

- 'CH1 Proportional band (P) setting' (Un\G431)
- 'CH1 Heating proportional band (Ph) setting' (Un\G431)
- 'CH1 Cooling proportional band (Pc) setting' (Un\G439)
- 'CH1 Integral time (I) setting' (Un\G432)
- 'CH1 Differential time (D) setting' (Un\G433)
- 'CH1 Loop disconnection detection judgment time' (Un\G537)*¹

*¹ A value that is twice as large as the value in 'CH1 Integral time (I) setting' (Un\G432) is automatically set. However, when this setting has been set to 0s at the auto tuning, the loop disconnection detection judgment time is not stored.

Precautions

- During setting change rate limiter operations, auto tuning starts after the set value (SV) reaches the AT point.
- Implement auto tuning if control has started with both the AT implementation command and ST implementation command in the 1 status.
- If the AT implementation command is set to 1 during start-up tuning, start-up tuning stops, and auto tuning is implemented.
- If a value other than 0 is set in the Output change ratio limiter and auto tuning is implemented, the optimum PID constant may not be obtainable. If implementing auto tuning, do not use the output change ratio limiter.
- During auto tuning implementation, the loop disconnection alert function is disabled.

Auto tuning implementation procedure

■Using the engineering tool

[Tool] ⇒ [Module Tool List]

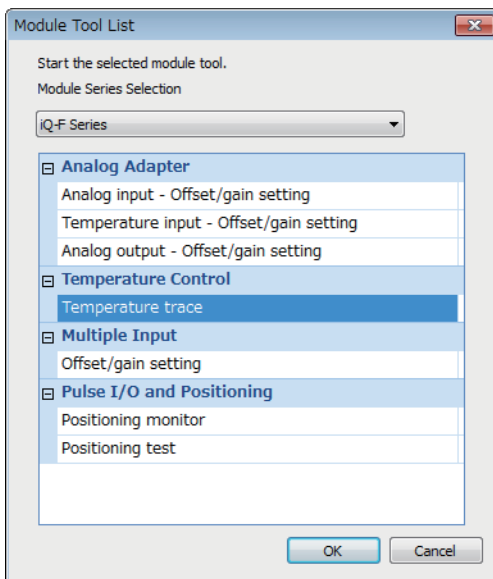

1. Select "Temperature trace" in "Temperature Control Module" and click the [OK] button.

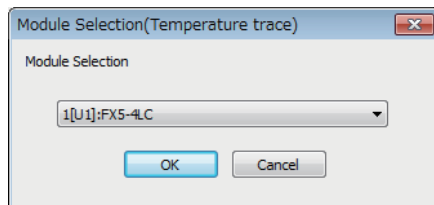

2. Select the module to configure the temperature control setting and click the [OK] button.

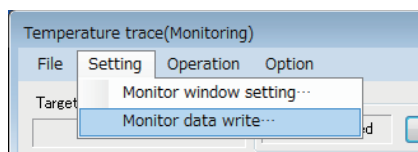

3. Select "Monitor data write" from the items described below.

[Setting] ⇒ [Monitor data write]

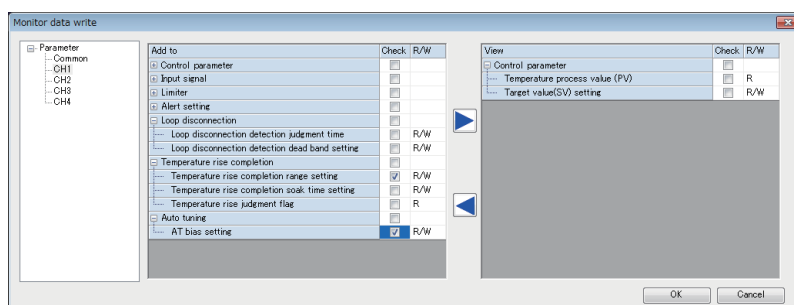

4. Select the parameter to be changed from "Add to" to click the ► button.

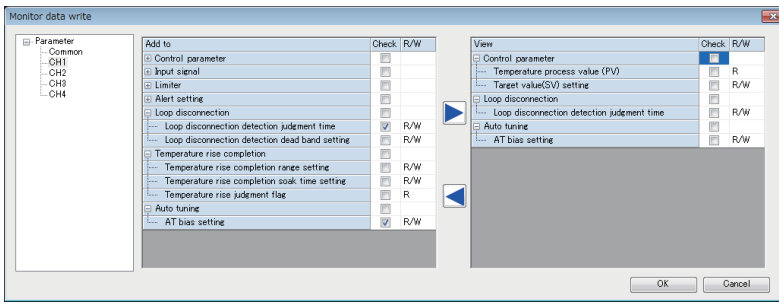

5. The parameter is added in "View".
6. Click the [OK] button.

Name	Color	Value
Parameter		
CH1Temperature process value (PV)	Blue	1370°C
CH2Temperature process value (PV)	Red	1370°C
CH3Temperature process value (PV)	Green	1370°C
CH4Temperature process value (PV)	Orange	1370°C
CH1Target value(SV) setting	Yellow	100°C
CH2Target value(SV) setting	Pink	0°C
CH3Target value(SV) setting	Light Blue	0°C
CH4Target value(SV) setting	Purple	0°C
CH1Loop disconnection detection judgment time	Dark Blue	480s
CH1AT bias setting	Red	0°C

7. Write the set value to be changed.

Name	CH1	CH2	CH3	CH4
Control command				
Setting/Operation mode command	1:Operation mode command			
Setting/Operation mode status	1:Operation mode			
Auto tuning command	1:ON	0:OFF	0:OFF	0:OFF
Auto tuning status	Executing	Stopped	Stopped	Stopped
Setting value back up command	0:OFF			
Setting value back up completed fla	0:OFF			
AUTO/MAN mode shift	0:AUTO	0:AUTO	0:AUTO	0:AUTO

8. Set "Setting/Operation mode command" to "1: Operation mode command".

9. Set "Auto tuning command" to "1: ON".

10. Set "Auto tuning command" to "1: ON", "Auto tuning status" becomes "Implementing" and the auto tuning starts.

11. When the auto tuning is completed, "Auto tuning status" becomes "Stopped".

12. The temperature control is implemented with the set PID constants.

Name	CH1	CH2	CH3	CH4
Control command				
Setting/Operation mode command	1:Operation mode command			
Setting/Operation mode status	1:Operation mode			
Auto tuning command	1:ON	0:OFF	0:OFF	0:OFF
Auto tuning status	Stopped	Stopped	Stopped	Stopped
Setting value back up command	0:OFF			
Setting value back up completed fla	0:OFF			
AUTO/MAN mode shift	0:AUTO	0:AUTO	0:AUTO	0:AUTO

■Using programs

Auto tuning is implemented using the following procedure.

1. Setting each data in the temperature control module

Set each data. (Page 36 Settings related to the auto tuning)

2. Operation mode setting

- Turn OFF→ON 'Setting/operation mode command' (Un\G399, b1). (Page 126 Setting/operation mode command (b1))
- Check that 'Setting/operation mode status' (Un\G398, b1) is ON. (Page 124 Setting/operation mode status (b1))

3. Starting auto tuning

Turn OFF→ON 'CH1 Auto tuning command' (Un\G399, b4). (Page 127 Auto tuning command (b4 to 7))

4. Implementing auto tuning

'CH1 Auto tuning status' (Un\G398, b4) is ON. (Page 125 Auto tuning status (b4 to 7))

5. After the completion of the auto tuning (setting PID constants)

'CH1 Auto tuning status' (Un\G398, b4) turns OFF and calculation values are set in the buffer memory. (Page 36 Storing the calculation values after auto tuning)

6. Temperature control using the set PID constants

The temperature control is implemented with the set PID constants.

Auto tuning implementation conditions and stop conditions

■Auto tuning implementation conditions

If all of the following conditions are satisfied, auto tuning can be implemented.

- AUTO/MAN mode switching is "0: AUTO mode"
- Operations mode setting is "3: Monitor + alert + control"
- Proportional band setting is other than 0
- The values of upper limit output limiter, heating upper limit output limiter, and cooling upper limit output limiter are all 1 (0.1%) min.
- The lower limit output limiter value is 999 (99.9%) max.
- No input value errors (upper limit/lower limit) have occurred
- Cascade ON/OFF is "0: Cascade OFF"
- AT/ST error completion flag is 0

■Auto tuning stop conditions

If any of the following conditions occur during auto tuning, auto tuning force-ends, and the AT/ST error completion flag turns ON.

- An input value error (upper limit/lower limit) occurs
- Control start/stop switching is changed to "0: Stop control"
- The set value (SV) is changed
- AUTO/MAN mode switching is changed to "1: MAN mode"
- Operations mode setting is changed to "3: Monitor + alert + control"
- 2-position operation is implemented (when proportional band is set to 0)
- The values in the upper limit outputs limiter, heating upper limit outputs limiter, cooling upper limit outputs limiter, and the lower limit outputs limiter are changed
- The sensor correction value is changed
- The primary delay digital filter value is changed
- The AT bias value is changed
- Normal Operation/Reverse Operation setting is changed
- Cooling method setting is changed
- The target value, AT bias, or settings limiter is changed, and the AT point (= Set value (SV) + AT bias) is outside the settings limiter range
- Cascade ON/OFF is changed to "1: Cascade ON"
- Auto tuning does not finish even if approx. 2 hours has elapsed since auto tuning started
- A hardware error (24 V DC power supply error, cooling contact temperature compensation error, or A/D converter error) is detected
- The calculated value of the auto tuning PID constant exceeds the settings range

4.13 AT (Auto Tuning) Bias Function

If the process value (PV) does not exceed the set value (SV) during auto tuning implementation, AT bias is set.

Auto tuning implements 2-position control on the set value (SV), and calculates and sets the PID constants by hunting the process value (PV). Depending on the control target, however, auto tuning using hunting may be poor. In such cases, the auto tuning set value (SV)= AT point can be changed using the AT bias settings.

Ex.

When a negative value has been set for AT bias (Reverse Operation)

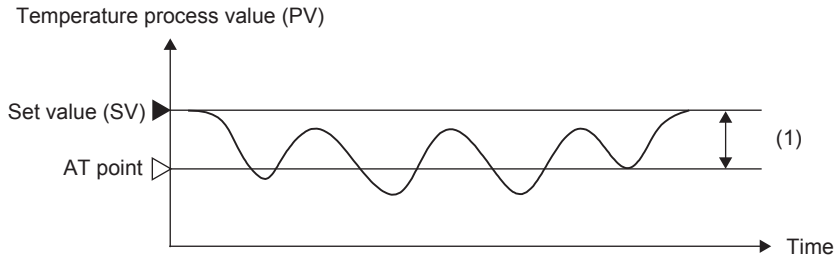

(1) 'CH1 AT bias' (Un\G546)

Precautions

- If the set value (SV) + AT bias (=AT point) is outside the settings limiter range, auto tuning is implemented using the settings limiter value.
- If the setting change rate limiter setting is other than 0 when auto tuning starts, the set value (SV) changes according to the settings variation rate limiter setting until the AT point is reached. At this time, the event AT implementation status (Un\G429, b14) turns ON after the set value reaches the AT point, and auto tuning starts.

Setting method

Configure the settings as described below.

🔗 [Navigation window] ⇒ [Parameter] ⇒ Target module ⇒ [Module Parameter] ⇒ [Application Setting] ⇒ [Auto tuning setting] ⇒ [AT bias]

4.14 Startup Tuning Function

Startup tuning is the function that automatically measures, calculates, and sets the optimal PID constants from the response characteristics of the control target either during control start or when the set value (SV) changes. If control starts as easy auto tuning, the PID constants can be requested in a short time from the control target with slow response without disturbing controllability. Further, if the control targets that require PID constants differ for each temperature setting, PID constants can be requested for each set value (SV) change.

Startup tuning starts automatically when either control starts or the set value (SV) changes if all of the startup tuning implementation conditions are satisfied.

If startup tuning finishes normally, control continues using the newly-calculated PID constants.

Operations during startup tuning

Assuming that all startup tuning implementation functions are satisfied. ( Page 42 Startup tuning implementation conditions)

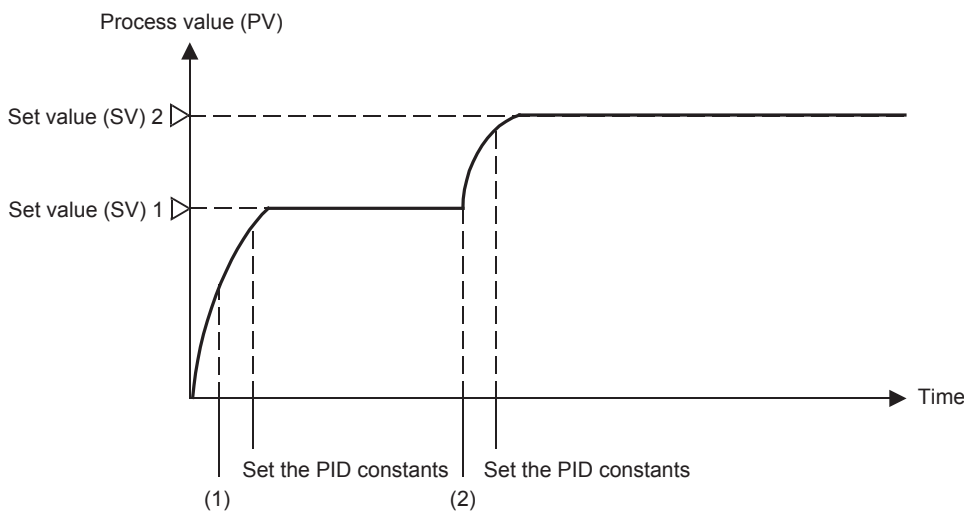

- (1) When control starts, startup tuning starts, and the optimal PID constants are calculated from the response characteristics of the target control, and the values stored in the buffer memories.
- (2) When the set values are changed, startup tuning starts, and the optimal PID constants are calculated from the response characteristics of the target control, and the values stored in the buffer memories.

Startup tuning implementation conditions and stop conditions

■ Startup tuning implementation conditions

If all of the following conditions are satisfied, startup tuning can be implemented.

- AUTO/MAN mode switching is "0: AUTO mode"
- Operations mode setting is "3: Monitor + alert + control"
- Proportional band setting is other than 0
- The values of upper limit output limiter, heating upper limit output limiter, and cooling upper limit output limiter are all 1 (0.1%) min.
- The lower limit output limiter value is 999 (99.9%) max.
- No input value errors (upper limit/lower limit) have occurred
- Cascade ON/OFF is "0: Cascade OFF"
- If using startup tuning when changing set values (SV), the process value (PV) is stable
- Outputs change when startup tuning starts, and are saturated by the upper limit outputs limiter or the lower limit outputs limited
- In startup tuning when control starts, the difference between the process value (PV) and set value (SV) is x2 or greater than the proportional band
- AT implementation command is 0
- AT/ST error completion flag is 0

■ Startup tuning stop conditions

If any of the following conditions occur during startup tuning, startup tuning force-ends, and the AT/ST error completion flag turns ON.

- An input value error (upper limit/lower limit) occurs
- Control start/stop switching is changed to "0: Stop control"
- AUTO/MAN mode switching is changed to "1: MAN mode"
- Operations mode setting is changed to "3: Monitor + alert + control"
- 2-position operation is implemented (when proportional band is set to 0)
- The values in the upper limit outputs limiter, heating upper limit outputs limiter, cooling upper limit outputs limiter, and the lower limit outputs limiter are changed
- The sensor correction value is changed
- The primary delay digital filter value is changed
- Cascade ON/OFF is changed to "1: Cascade ON"
- Startup tuning does not finish even if approx. 100 mins. has elapsed since startup tuning started
- A hardware error (24 V DC power supply error, cooling contact temperature compensation error, or A/D converter error) is detected
- AT implementation command is set to 1
- Manipulated value saturation time is too short
- The calculated value of the startup tuning PID constant exceeds the settings range

Precautions

- To implement startup tuning when control starts, make sure to turn ON the heater power supply at the same time or before starting startup tuning.
- Start startup tuning when the difference between the process value (PV) and set value (SV) is x2 or greater than the proportional band when startup tuning starts.
- If limiting the manipulated value using the output limiter, the optimal PID constants may not be obtainable even if startup tuning was implemented.
- If the output change ratio limiter is set, the optimal PID constants may not be obtainable even if startup tuning was implemented.
- During data measurements for calculations, an error completion may occur if the set value (SV) is changed so that the manipulated output is excluded from the saturation status.

4.15 Operations Mode Selection Function

This function selects the operations mode for each channel.

Operation mode	Operation
0: Not used	This mode does not implement monitoring, alert operations, or controls.
1: Monitor only	This mode only monitors the process values. If external inputs are selected, values written to the temperature measurement values for external (other analog module) inputs are processed as the process values.
2: Monitor + alert	This mode monitors the process values and implements alert operations. Alert operations are implemented only when control start/stop switching is set to "Start control".
3: Monitor + alert + control	This mode implements monitoring, alert operations, and controls. Alert operations and controls are implemented only when control start/stop switching is set to "Start control".

The operations statuses using a combination of control start/control stop are as described below.

Control start/ control stop	Description	Operation mode			
		Not used	Monitor only	Monitor + alert	Monitor + alert + control
0: Control stop	Measurement value (PV)	Displays 0	Displays the process value		
	Manipulated value (MV)	Displays 0	Displays -50		
	Alert operation	Disable			
	Temperature rise completion judgment	Disable			
	Output (Transistor outputs selection 0 to 2) ^{*1}	Outputs OFF			
	Output (Transistor outputs selection 3 to 6) ^{*1}	Outputs OFF			
	Output (Transistor outputs selection 7) ^{*1}	Outputs OFF			
1: Control start	Measurement value (PV)	Displays 0	Displays the process value		
	Manipulated value (MV)	Displays 0	Displays -50		Displays the manipulated value
	Alert operation	Disable		Enable	
	Temperature rise completion judgment	Disable			Enable
	Output (Transistor outputs selection 0 to 2) ^{*1}	Outputs OFF			Control outputs
	Output (Transistor outputs selection 3 to 6) ^{*1}	Outputs OFF		Alert status	
	Output (Transistor outputs selection 7) ^{*1}	Outputs OFF			Loop disconnection alert status

*1 For the transistor outputs selection function, refer to  Page 53 Transistor Outputs Selection Function.

Setting method

Configure the settings as described below.

 [Navigation window] ⇒ [Parameter] ⇒ Target module ⇒ [Module Parameter] ⇒ [Base Setting] ⇒ [Operations mode setting]

4.16 Cascade Control

Cascade control is a method of control as a single control loop by combining two controls: the master channel and slave channel. Ideal for when there is a large time delay between the temperature near the heat source and the temperature of the control target.

- The master channel calculated PID as either control target process value (PV) inputs or external input value inputs, and converts the control inputs into cascade signals using the cascade bias and cascade gain to correct the slave channel set values (SV).
- The slave channel implements PID control using the set values (SV) converted into cascade signals.

The channel combinations that can be used by the master channel and slave channel are determined for each control loop. For the channel combinations, refer to the following.

Control loop	Master channel	Slave channel
Control group 1 (GR1)	Channel 1	Channel 2
Control group 2 (GR2)	Channel 3	Channel 4

Ex.

Control loop 1 block diagram

Control loop 1

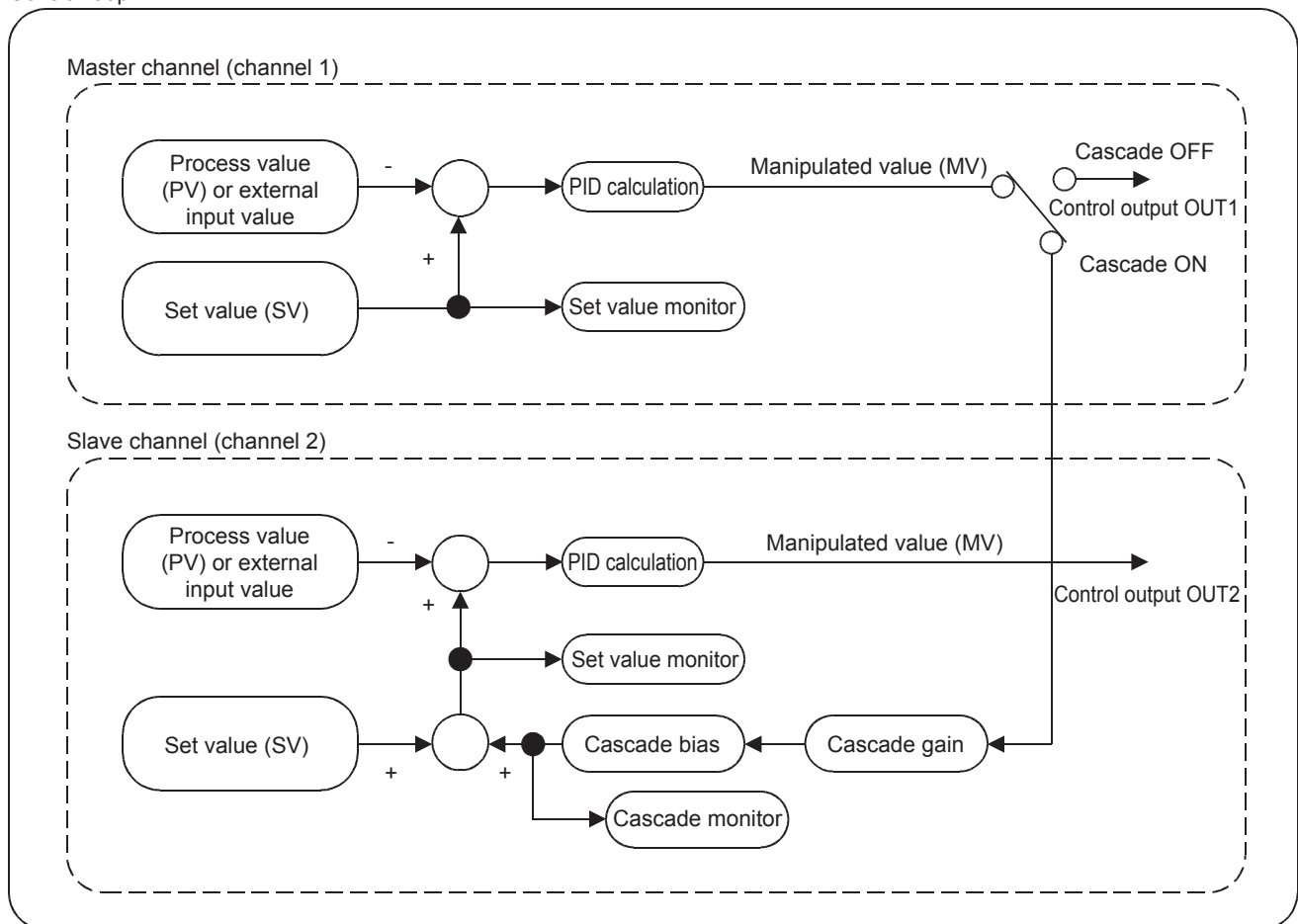

Point

The conditions that enable cascade control are as described below.

- Master and slave channels are separate, and a suitable intermediate control amount can be selected
- Response speed of the control target is sufficiently faster for the slave channel than for the master channel

Precautions

- Depending on the control conditions, it may be necessary to limit the movement area of the slave controller using "cascade gain" and "cascade bias".
- During cascade control, auto tuning and startup tuning cannot be implemented.

Setting method

Configure the settings as described below.

 [Navigation window] ⇒ [Parameter] ⇒ Target module ⇒ [Module Parameter] ⇒ [Application Setting] ⇒ [Cascade function]

Tuning during cascade control

During cascade control, tuning (auto tuning and startup tuning) cannot be used. Turn OFF cascade control before implementing tuning, and set benchmark PID constants.

Implement tuning for each channel separately, and stop control for the channels that are not to be tuned. (Set the operations mode settings to "0: Not used", "1: Monitor only", or "2: Monitor + alert".)

■ Tuning procedure example

1. Set only the slave channel to control status and implement auto tuning to request the slave channel PID constants.

Point

Implementing PID control on both the master and slave channels during cascade control may cause integral operations to raise the low frequency gain too high, causing slow cycle vibration response in one or other of the channels.

Consequently, generally set the slave channel so that this phenomenon does not occur using either P control (I=0, D=0) or PD control (I=0).

Either the P control constant or PD control constant determines the auto tuning results implemented by the slave channel as standard, and sets the proportional band to approx. $\times 1.4$.

2. Set only the master channel to control status and implement auto tuning to request the master channel PID constants.
3. Set the same master channel and slave channel set values (SV).
4. Turn OFF cascade status, and implement control for the slave channel only. Set the master channel operations mode to either "1: Monitor" or "2: Monitor + alert", and wire control outputs for the slave channel only.
5. When the master and slave channel process values (PV) are stable, request the difference E_n in the process values (PV) between the master channel and the slave channel. (Master channel process value (PV) - slave channel process value (PV))
6. Set the slave channel set value range to approx. $\times 4$ the process value difference E_n determined in Step 5, and set the cascade gain. (Slave channel set value range \div slave channel inputs range span)
7. Set the cascade bias. (Slave channel set value range $\div 2$)
8. Set the slave channel set value. (Master channel set value (SV) - Process value difference E_n)
9. Set the master channel operations mode setting to "3: Monitor + alert + control", and turn ON cascade control. Check the control status while manually adjusting the master channel PID constants.

4.17 SV Tracking Function

The SV tracking function tracks the slave channel set value in the set values immediately before switching (set value monitor value) when turning OFF cascade. This prevents sudden changes to the slave channel outputs when turning OFF cascade.

- Control group 1 (GR1): Common setting for CH1 and CH2.
- Control group 2 (GR2): Common setting for CH3 and CH4.

Operation example

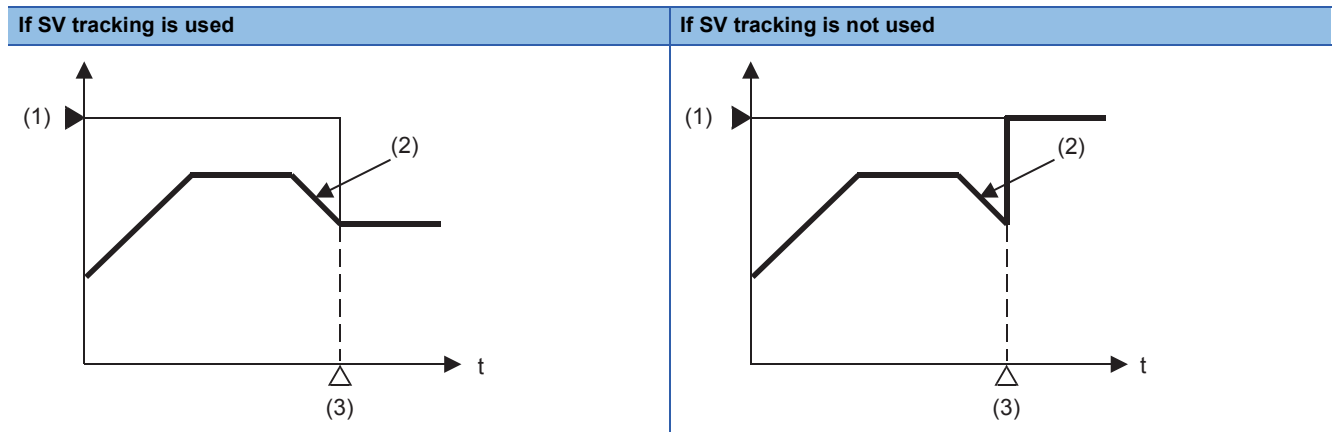

- (1) Slave channel set value (SV) setting
 (2) Slave channel set value monitor
 (3) Cascade control ON→OFF switching point

Setting method

Configure the settings as described below.

[Navigation window] ⇒ [Parameter] ⇒ Target module ⇒ [Module Parameter] ⇒ [Application Setting] ⇒ [Cascade setting] ⇒ [SV tracking selection]

4.18 Settings Limiter Function

The settings limiter function limits the settings range of the set value (SV).

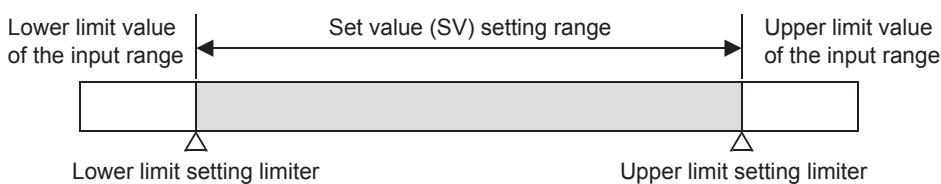

Setting method

Configure the settings as described below.

[Navigation window] ⇒ [Parameter] ⇒ Target module ⇒ [Module Parameter] ⇒ [Application Setting] ⇒ [Limiter setting]

Point

Set the settings limiter settings range using the inputs range upper limit \geq upper limit limiter \geq lower limit limiter \geq input range lower limit.

4.19 Setting Change Rate Limiter Setting Function

The setting change rate limiter settings is the function that changes the set value (SV) difference in steps when the set value (SV) is changed. Set so as to avoid sudden set value (SV) changes. Set values (SV) undergoing changes can be checked using 'Set value (SV) monitor' (Un\G406).

Ex.

If the set value is raised from set value (SV) 1 to set value (SV) 2

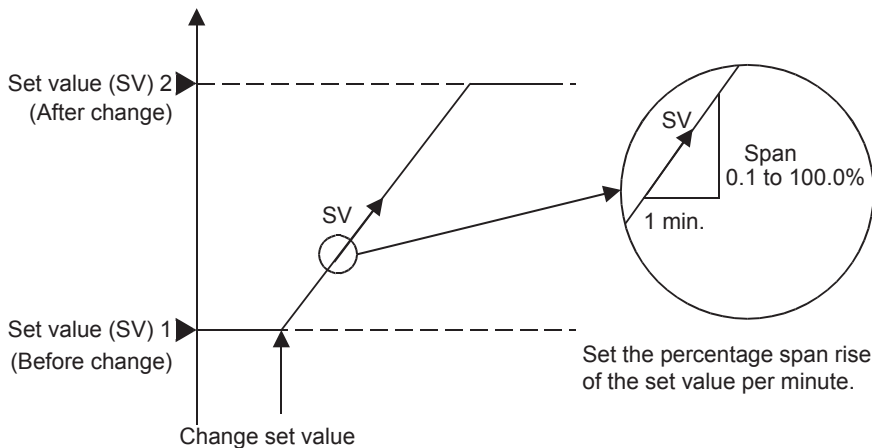

Setting method

Set the span change amount (%) per 1 minute. The span types are as described below.

Input type	Span
During internal temperature inputs	Input range span
During internal micro voltage inputs	Scaling span
During external inputs	External inputs span

Change amount setting

Set only "Setting change rate limiter".

[Navigation window] ⇒ [Parameter] ⇒ Target module ⇒ [Module Parameter] ⇒ [Application Setting] ⇒ [Limiter setting]

Precautions

The value including below the decimal point is handled. Set the actual value using the value multiplied by 10.

4.20 Input Type Selection Function

The thermocouple/platinum resistance thermometer type, temperature measurement range, and micro voltage input can be switched for each channel. Implementable in settings mode only.

The value displayed in the process value when micro voltage input is selected is from the micro voltage input scaling lower limit to the micro voltage input scaling upper limit Set so that span (upper limit - lower limit absolute values) is 20000 max., and "micro voltage input scaling upper limit" is greater than "micro voltage input scaling lower limit".

Setting method

Configure the settings as described below.

[Navigation window] ⇒ [Parameter] ⇒ Target module ⇒ [Module Parameter] ⇒ [Application Setting] ⇒ [Control basic parameters] ⇒ [Input range setting]

4.21 Sensor Correction Function

When there is an error between the temperature process value (PV) and actual temperature due to measurement conditions, this function corrects the error.

Sensor correction operations

The process value (PV) and flag (input error) statuses are as shown in the following table depending on the relationship between the process value before correction and the value after correction.

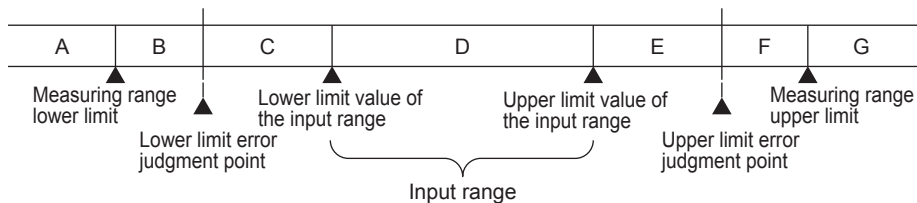

Process value before correction	Value after correction	Temperature process value (PV)	Flag (input error) status	Remarks
Area A	—	Display lower limit value	Input error (lower limit) status is ON	If the process value before correction is in area A, correction processing is not implemented
Area B	Areas A and B	Display lower limit value	Input error (lower limit) status is ON	Values after correction are not input to areas E, F, or G
	Areas C and D	Value after correction		
Area C	Areas A and B	Display lower limit value	OFF	Values after correction are not input to areas E, F, or G
	Areas C and D	Value after correction		
Area D	Areas A and B	Display lower limit value	OFF	—
	Areas C, D, and E	Value after correction		
	Areas F and G	Display upper limit value		
Area E	Areas D and E	Value after correction	OFF	Values after correction are not input to areas A, B, or C
	Areas F and G	Display upper limit value		
Area F	Areas D and E	Value after correction	Input error (upper limit) status is ON	Values after correction are not input to areas A, B, or C
	Areas F and G	Display upper limit value		
Area G	—	Display upper limit value	Input error (upper limit) status is ON	If the process value before correction is in area G, correction processing is not implemented

Setting method

Set the span correction as described below.

 [Navigation window] ⇨ [Parameter] ⇨ Target module ⇨ [Module Parameter] ⇨ [Application Setting] ⇨ [Sensor correction value setting]

The span types are as described below.

Input type	Span
During internal temperature inputs	Input range span
During internal micro voltage inputs	Scaling span
During external inputs	External inputs span

Precautions

The value including below the decimal point is handled. Set the actual value using the value multiplied by 100.

4.22 Primary Delay Digital Filter

By setting the primary delay digital filter, a temperature process value (PV) with smoothed transient noise can be output.

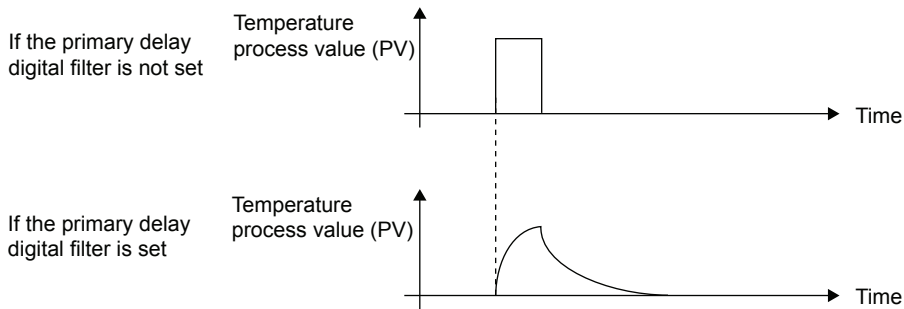

Set the time for the temperature process value (PV) to change by 63.3% in the primary delay digital filter.

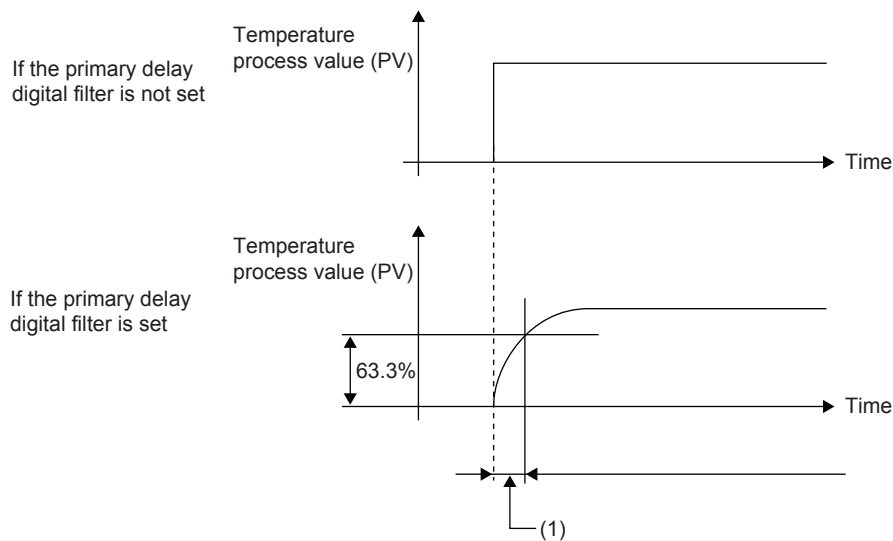

(1) "Primary Delay Digital Filter Setting" in "Application Setting"

Setting method

Configure the settings as described below.

[Navigation window] ⇒ [Parameter] ⇒ Target module ⇒ [Module Parameter] ⇒ [Application Setting] ⇒ [Primary Delay Digital Filter Setting]

4.23 Temperature Rise Judgment Function

This function judges whether the temperature process value (PV) is within the temperature rise completion range.

Setting method

Configure the settings as described below.

■Temperature rise completion range setting

Specify the width of the temperature rise completion range for the set value (SV).

[Navigation window] ⇒ [Parameter] ⇒ Target module ⇒ [Module Parameter] ⇒ [Application Setting] ⇒ [Temperature rise completion setting] ⇒ [Temperature rise completion range setting]

■Temperature rise completion soak time

Set the time taken to turn ON 'CH1 Temperature rise judgment flag' (Un\G404) after temperature rise completion.

[Navigation window] ⇒ [Parameter] ⇒ Target module ⇒ [Module Parameter] ⇒ [Application Setting] ⇒ [Temperature rise completion setting] ⇒ [Temperature rise completion soak time setting]

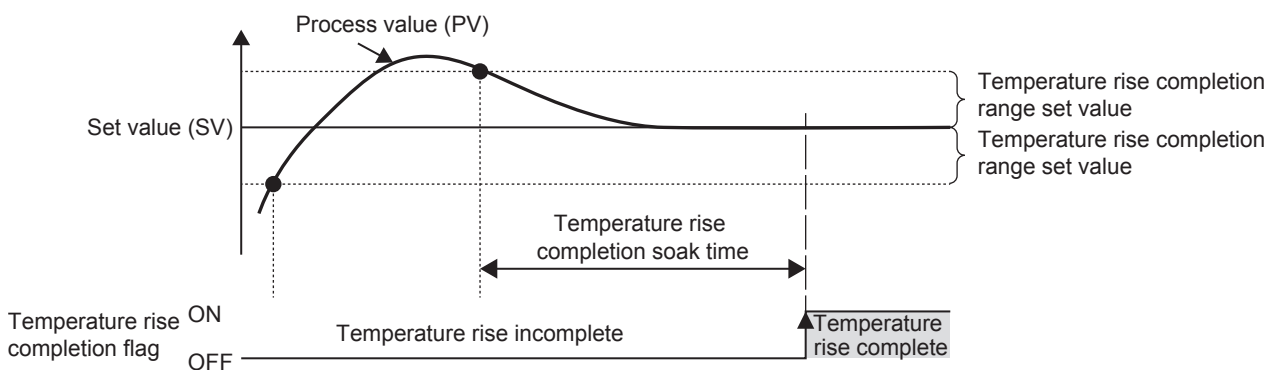

4.24 External (Other Analog Module) I/O Function

This function enables inputs and outputs using another analog module on the system.

Input

The temperature control module generally uses the temperature processed by the thermocouple or platinum resistance thermometer connected to the module as the temperature process value (PV). The temperature control module can use the digital input value of the current or voltage converted in another analog module on the system as a temperature process value (PV).

■Setting method

Store the value of another analog module in 'CH1 Temperature process value (PV) for input with another (external) analog module' (Un\G438).

Point

Select the control mode to use the external inputs using control mode switching.

- If a greater value than (external input range upper limit + 5% of external input range) is set, an input upper limit alert occurs, and an event (Un\G429, b0) turns ON.
- If a smaller value than (external input range lower limit + -5% of external input range) is set, an input lower limit alert occurs, and an event (Un\G429, b1) turns ON.

Output

Instead of the transistor output from inside the temperature control module, an analog output value from another analog module can be used as the manipulated value (MV).

■Setting method

Store the value in 'CH1 Manipulated value (MV) for output with another analog module' (Un\G407) in the buffer memory of another analog module.

Point

The values that scale the manipulated value (MV) (from the external output range lower limit (Un\G596) to the external output range upper limit (Un\G595)) are written to the 'CH1 Manipulated value (MV) for output with another (external) analog module'/'CH1 Manipulated value for heating (MVh) for output with another (external) analog module' (Un\G407) and 'CH1 Manipulated value for cooling (MVc) for output with another (external) analog module' (Un\G409), regardless of the control mode switching settings.

4.25 Output Limiter Function

This function sets the upper and lower limit values if outputting the manipulated value (MV) calculated using PID operations to an external device.

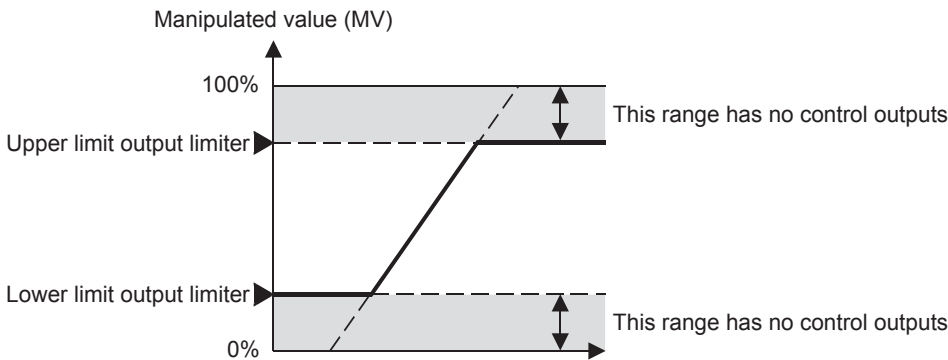

Setting method

Configure the settings as described below.

[Navigation window] ⇒ [Parameter] ⇒ Target module ⇒ [Module Parameter] ⇒ [Application Setting] ⇒ [Limiter setting]

Precautions

The output limiter function is disabled during 2-position control implementation.

4.26 Output Change Ratio Limiter Function

The output change ratio limiter functions to limit the amount of change in the manipulated value (MV) per unit time (1s). Control outputs can be limited using the output change rate that has been set.

Outputs are based on set tendencies without the manipulated value (MV) changing suddenly during operations mode travel (when outside the proportional band) or when the set value (SV) changes (when the change is large).

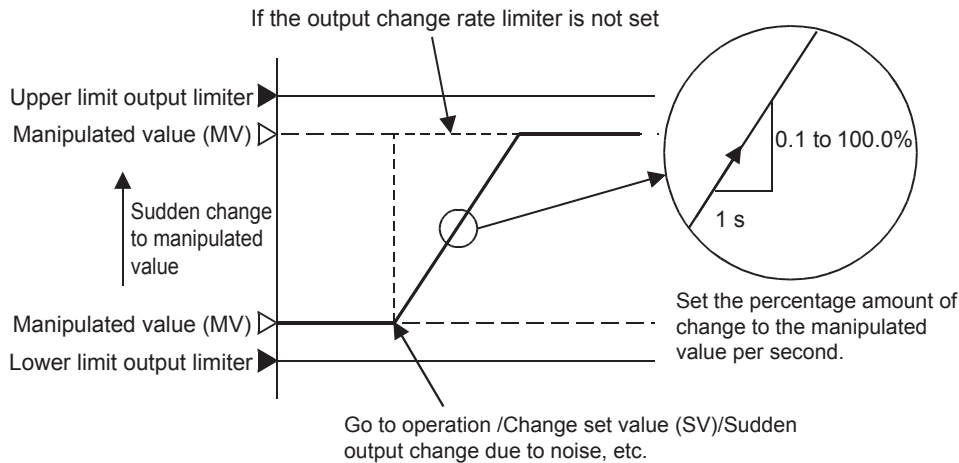

Setting method

Configure the settings as described below.

[Navigation window] ⇒ [Parameter] ⇒ Target module ⇒ [Module Parameter] ⇒ [Application Setting] ⇒ [Limiter setting]

Precautions

- Reducing the output change ratio limiter value (reducing the tendency) slows the control response. Further, differential effects are eliminated.
- The output change ratio limiter is disabled during 2-position control implementation.
- If a value other than 0 is set in the output change ratio limiter and auto tuning is implemented, a suitable PID constant may not be obtainable.

4.27 Control Output Flag

This function monitors the ON and OFF status of the control outputs.

If internal outputs are selected in the control outputs, transistor outputs for the temperature control module will be implemented.

If external outputs is selected in the control outputs, the output status uses the time proportional calculation results. Checkable using the "CH1 Transistor output flag" (Un\G405).

4.28 Transistor Outputs Selection Function

The transistor outputs selection function is the function that selects the internal transistor outputs function. Settings are made for each channel separately.

The transistor output functions depend on the control mode settings as described below.

Transistor output functions selection set values		Control mode			
		0, 1: Standard PID control (Internal outputs)	2, 3: Standard PID control (External outputs)	4, 5: Heating/cooling PID control (Internal outputs)* ¹	6, 7: Heating/cooling PID control (External outputs)
0	OUT1	CH1 operations output	Normally OFF	CH1 heating operations output	Normally OFF
	OUT2	CH2 operations output	Normally OFF	CH1 cooling operations output	Normally OFF
	OUT3	CH3 operations output	Normally OFF	CH3 heating operations output	Normally OFF
	OUT4	CH4 operations output	Normally OFF	CH3 cooling operations output	Normally OFF
1	OUT1	CH1 operations output	CH1 operations output	CH1 heating operations output	CH1 heating operations output
	OUT2	CH2 operations output	CH2 operations output	CH1 cooling operations output	CH2 heating operations output
	OUT3	CH3 operations output	CH3 operations output	CH3 heating operations output	CH3 heating operations output
	OUT4	CH4 operations output	CH4 operations output	CH3 cooling operations output	CH4 heating operations output
2	OUT1	CH1 operations output	CH1 operations output	CH1 heating operations output	CH1 cooling operations output
	OUT2	CH2 operations output	CH2 operations output	CH1 cooling operations output	CH2 cooling operations output
	OUT3	CH3 operations output	CH3 operations output	CH3 heating operations output	CH3 cooling operations output
	OUT4	CH4 operations output	CH4 operations output	CH3 cooling operations output	CH4 cooling operations output
3	OUT1	CH1 operations output	CH1 alert 1 status	CH1 heating operations output	CH1 alert 1 status
	OUT2	CH2 operations output	CH2 alert 1 status	CH1 cooling operations output	CH2 alert 1 status
	OUT3	CH3 operations output	CH3 alert 1 status	CH3 heating operations output	CH3 alert 1 status
	OUT4	CH4 operations output	CH4 alert 1 status	CH3 cooling operations output	CH4 alert 1 status
4	OUT1	CH1 operations output	CH1 alert 2 status	CH1 heating operations output	CH1 alert 2 status
	OUT2	CH2 operations output	CH2 alert 2 status	CH1 cooling operations output	CH2 alert 2 status
	OUT3	CH3 operations output	CH3 alert 2 status	CH3 heating operations output	CH3 alert 2 status
	OUT4	CH4 operations output	CH4 alert 2 status	CH3 cooling operations output	CH4 alert 2 status
5	OUT1	CH1 operations output	CH1 alert 3 status	CH1 heating operations output	CH1 alert 3 status
	OUT2	CH2 operations output	CH2 alert 3 status	CH1 cooling operations output	CH2 alert 3 status
	OUT3	CH3 operations output	CH3 alert 3 status	CH3 heating operations output	CH3 alert 3 status
	OUT4	CH4 operations output	CH4 alert 3 status	CH3 cooling operations output	CH4 alert 3 status
6	OUT1	CH1 operations output	CH1 alert 4 status	CH1 heating operations output	CH1 alert 4 status
	OUT2	CH2 operations output	CH2 alert 4 status	CH1 cooling operations output	CH2 alert 4 status
	OUT3	CH3 operations output	CH3 alert 4 status	CH3 heating operations output	CH3 alert 4 status
	OUT4	CH4 operations output	CH4 alert 4 status	CH3 cooling operations output	CH4 alert 4 status
7	OUT1	CH1 operations output	CH1 loop disconnection alert status	CH1 heating operations output	Normally OFF
	OUT2	CH2 operations output	CH2 loop disconnection alert status	CH1 cooling operations output	Normally OFF
	OUT3	CH3 operations output	CH3 loop disconnection alert status	CH3 heating operations output	Normally OFF
	OUT4	CH4 operations output	CH4 loop disconnection alert status	CH3 cooling operations output	Normally OFF

*1 If control modes 4 or 5 are selected, use CH2 and CH4 control outputs or external outputs.

Setting method

Configure the settings as described below.

 [Navigation window] ⇒ [Parameter] ⇒ Target module ⇒ [Module Parameter] ⇒ [Application Setting] ⇒ [Transistor outputs function]

4.29 Alert Function

This function sends an alert when a temperature process value (PV) or deviation (E) meets the condition set in advance. Use this function to activate danger signals of devices or safety devices. The alert functions are classified into input alerts and deviation alerts, and are as described below depending on the alert mode set value.

Setting value	Alert mode	Setting range of alert set value
0	Not Warning (Alert not implemented)	—
1	Upper limit input value alert	Value within set input value range ^{*1}
2	Lower limit input value alert	
3	Upper Limit Deviation Alert	- span to + span ^{*2}
4	Lower Limit Deviation Alert	
5	Upper/lower Limit Deviation Alert	0 to + span ^{*2}
6	Within-Range Alert	
7	Upper limit input alert with wait	Value within set input range ^{*1}
8	Lower limit input alert with wait	
9	Upper Limit Deviation Alert with wait	- span to + span ^{*2}
10	Lower Limit Deviation Alert with wait	
11	Upper/lower Limit Deviation Alert with wait	0 to + span ^{*2}
12	Upper Limit Deviation Alert with Re-wait	
13	Lower Limit Deviation Alert with Re-wait	- span to + span ^{*2}
14	Upper/Lower Limit Deviation Alert with Re-wait	

*1 During internal temperature inputs, input range. During internal micro voltage inputs, scaling range. During external inputs, external input range.

*2 During internal temperature inputs, input range span. During internal micro voltage inputs, scaling span. During external inputs, external input span.

Input alert

When the temperature process value (PV) is equal to or greater than the alert set value, the system issues the upper limit input alert.

When the temperature process value (PV) is equal to or smaller than the alert set value, the system issues the lower limit input alert.

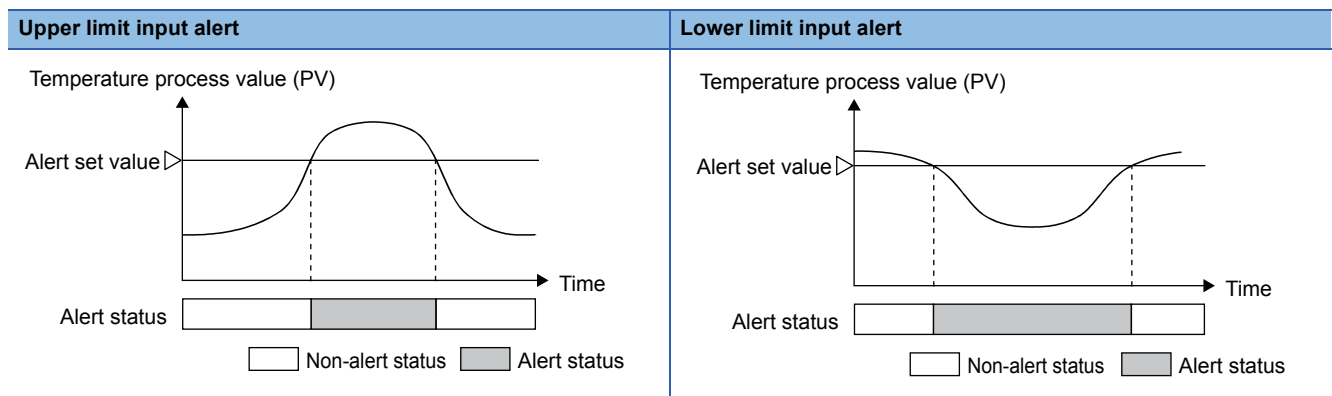

Setting method

Set an alert mode. (☞ Page 59 Alert mode)

- Upper limit input alert: Set "Upper Limit Input Alert" as the alert mode.
- Lower limit input alert: Set "Lower Limit Input Alert" as the alert mode.

Deviation alert

When the deviation (E) between the temperature process value (PV) and the set value (SV) meets a particular condition, the system issues the deviation alert.

The set value (SV) that is referenced is the "set value (SV) monitor".

■Setting the set value (SV) and the setting change rate limiter

If the Setting change rate limiter has been set: The "CH1 set value (SV) monitor" (Un\G406) obeys the set value (SV) after the change as described below.

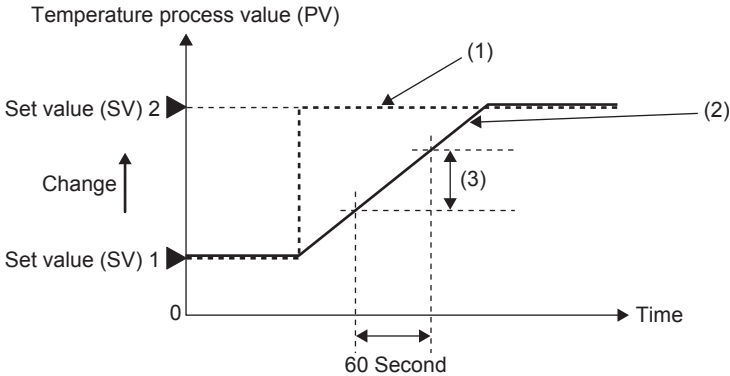

(1) "Set value (SV) Setting" of "Control basic parameters" in "Application Setting"

(2) "CH1 Set value (SV) monitor" (Un\G406)

(3) "Setting change rate limiter" of "Limiter setting" in "Application Setting"

■Upper limit deviation alert

When the deviation (E) is equal to or greater than the alert set value, the system issues a deviation alert.

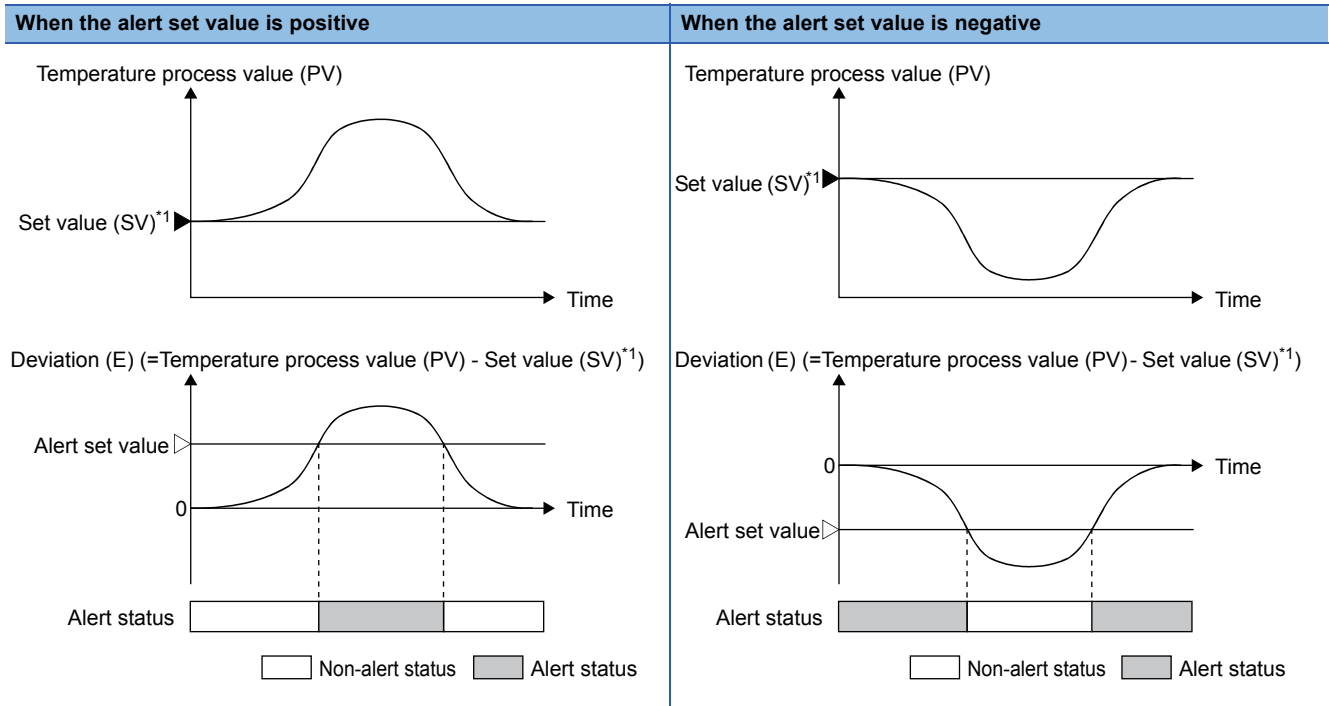

*1 Depending on the alert mode setting, this value becomes the set value or the monitored value. The setting range of the alert set value is -(Full scale of the input range) to the full scale of the input range. (Page 55 Setting the set value (SV) and the setting change rate limiter)

■ Lower limit deviation alert

When the deviation (E) is equal to or smaller than the alert set value, the system issues a deviation alert.

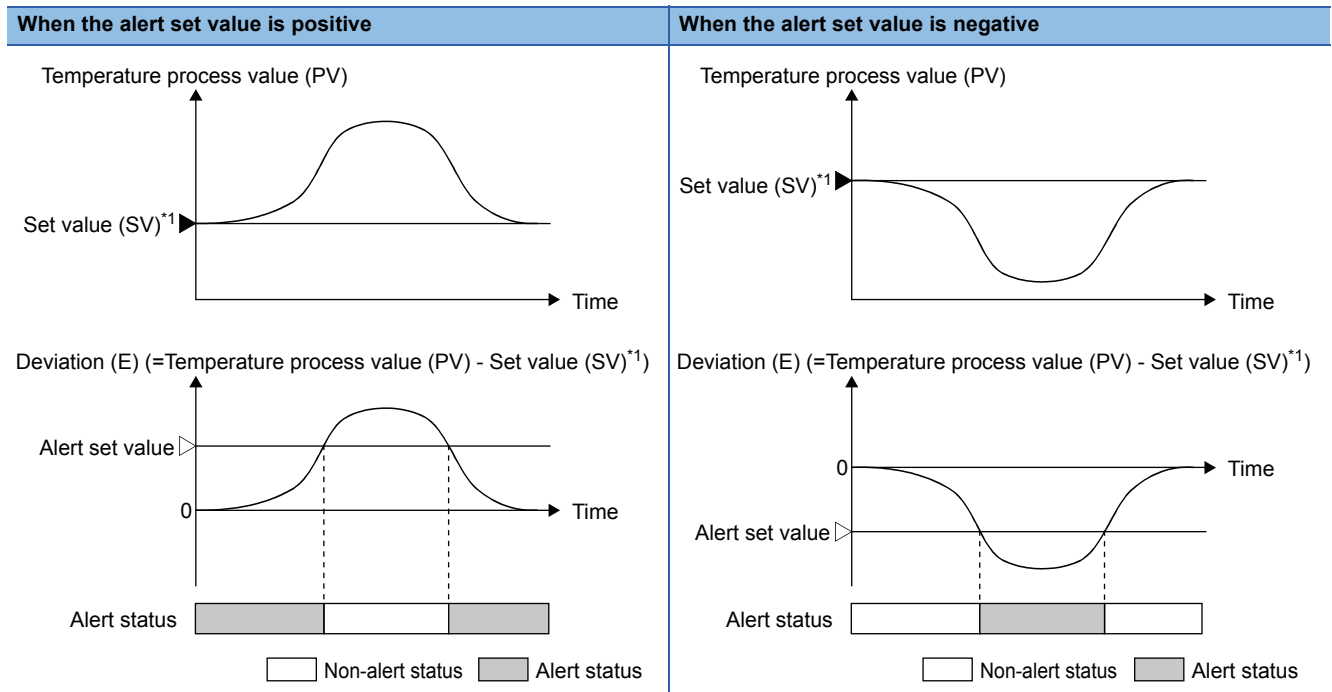

*1 Depending on the set alert mode, this value becomes the set value or the monitored value. The setting range of the alert set value is (-Full scale of the input range) to the full scale of the input range. (Page 55 Setting the set value (SV) and the setting change rate limiter)

■ Upper/lower limit deviation alert

When one of the following conditions is satisfied, the system issues a deviation alert.

- Deviation (E) \geq Alert set value
- Deviation (E) \leq -(Alert set value)

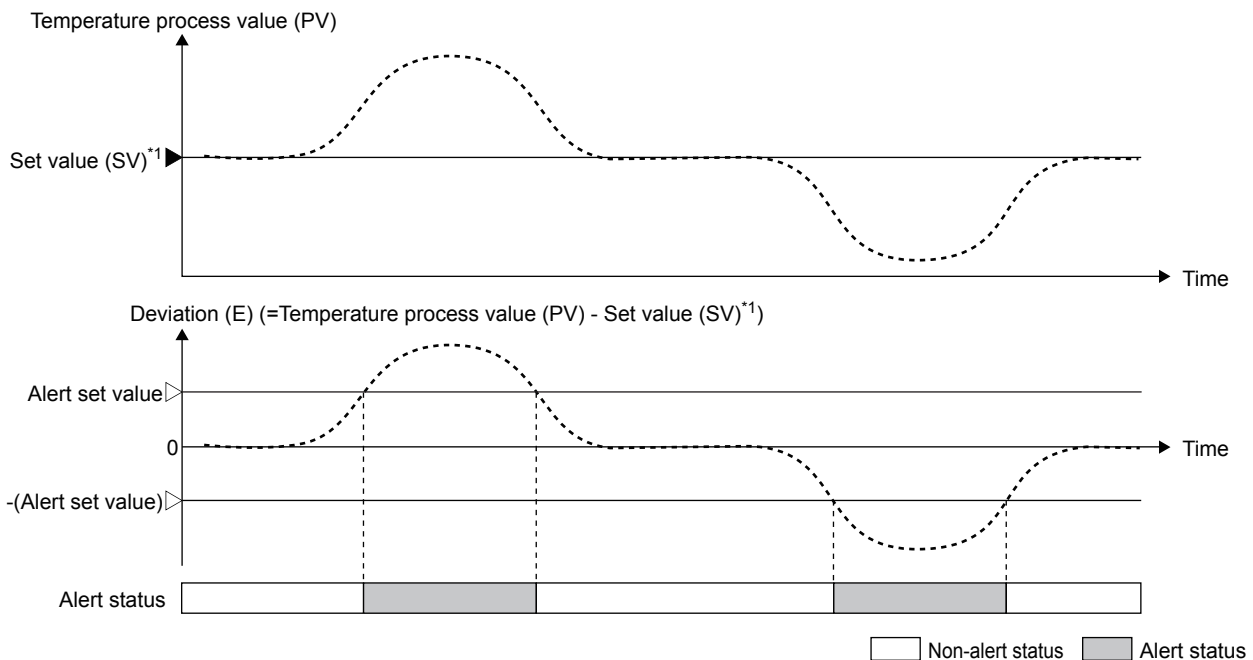

*1 Depending on the alert mode setting, this value becomes the set value or the monitored value. The setting range of the alert set value is (-Full scale of the input range) to the full scale of the input range. (Page 55 Setting the set value (SV) and the setting change rate limiter)

■ Within-range alert

When the following condition is satisfied, the system issues an alert.

- $-(\text{Alert set value}) \leq \text{Deviation (E)} \leq \text{Alert set value}$

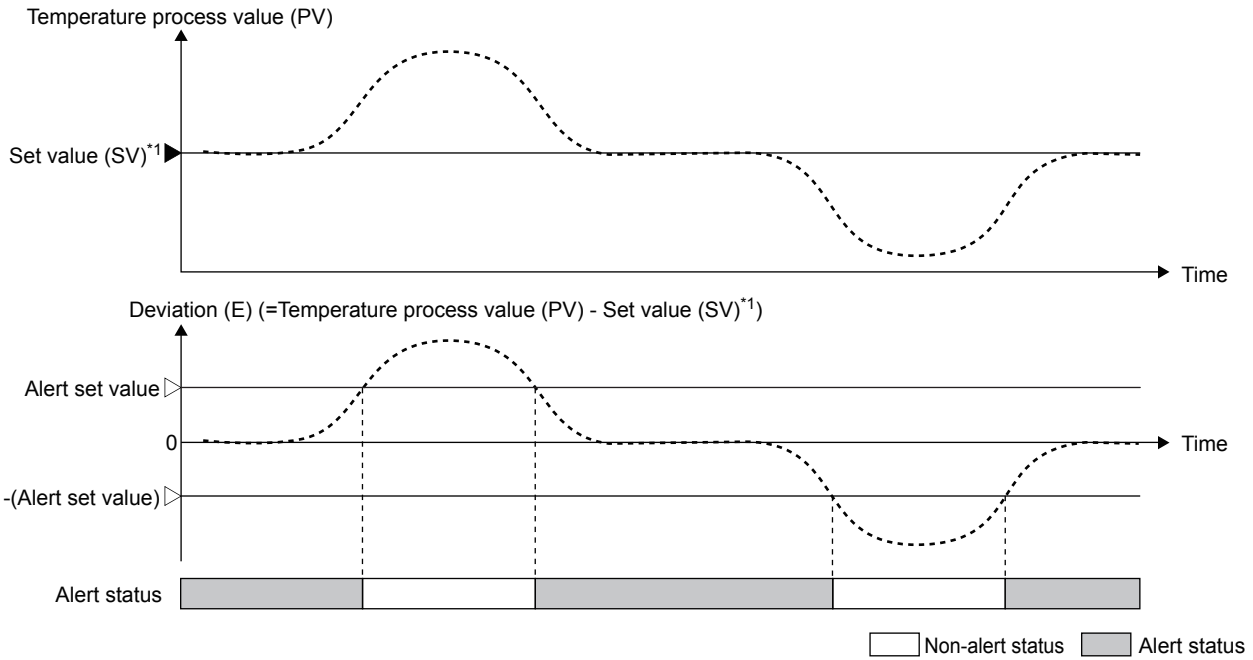

*1 Depending on the alert mode setting, this value becomes the set value or the monitored value. The setting range of the alert set value is $(-\text{Full scale of the input range})$ to the full scale of the input range. (Page 55 Setting the set value (SV) and the setting change rate limiter)

Alert with wait

Even though the temperature process value (PV) or deviation (E) has been in an alert status when the mode is shifted from the setting mode to the operation mode ('Setting/operation mode command' (Un\G399, b1) is turned OFF→ON), this condition is ignored and no alert occurs. The alert function can be disabled until the temperature process value (PV) or deviation (E) condition in which an alert occurs ceases.

Ex.

When the alert mode has been set to "Lower Limit Deviation Alert with Wait"

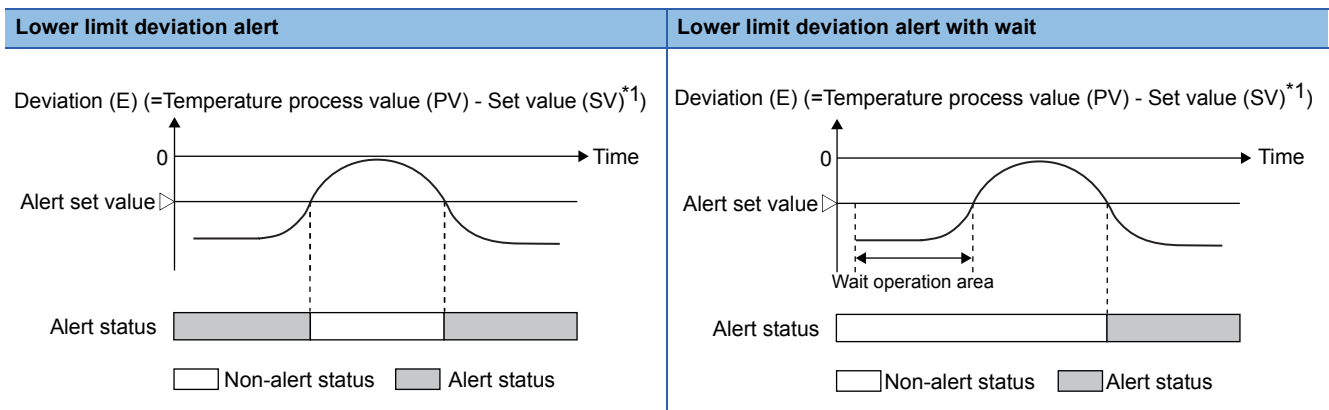

*1 Depending on the alert mode setting, this value becomes the set value or the monitored value. (Page 55 Setting the set value (SV) and the setting change rate limiter)

Point

When the system enters non-alert status even once after an alert judgment has started following the set alert mode, alert with wait is disabled even though the mode is shifted to alert with wait.

■Setting method

Select one of the following alert modes. (☞ Page 59 Alert mode)

Alert mode setting	
Setting value	Alert mode name
7	Upper limit input alert with wait
8	Lower limit input alert with wait
9	Upper limit deviation alert with wait
10	Lower limit deviation alert with wait
11	Upper/lower limit deviation alert with wait

Alert with re-wait

A function to disable the alert function once again when the set value (SV) is changed is added to an alert with wait. This is called an alert with re-wait.

When a control that changes the set value (SV) is implemented, the alert that is supposed to occur can be avoided when the set value (SV) is changed by selecting an alert with re-wait.

Ex.

When the temperature process value (PV) is at the position shown as below before the set value (SV) change

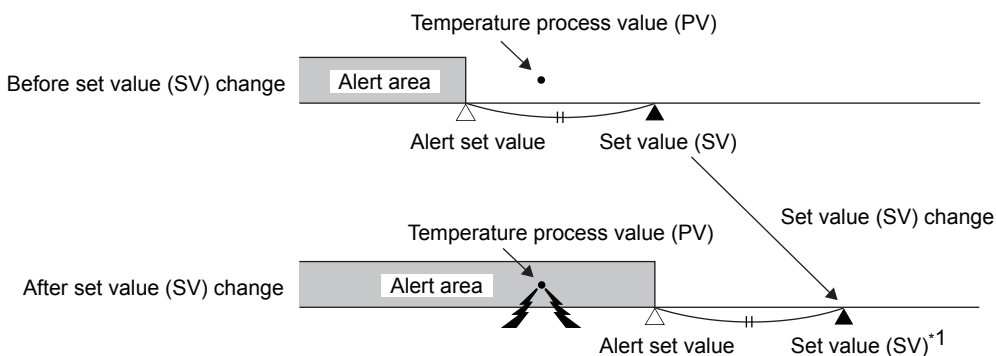

*1 Depending on the alert mode setting, this value becomes the set value or the monitored value. (☞ Page 55 Setting the set value (SV) and the setting change rate limiter)

When the set value (SV) of a deviation alert is changed, the temperature process value (PV) enters the alert area, so the system enters alert status. To prevent the case described above, alert outputs can be suspended.

■Setting method

Select one of the following alert modes.

Alert mode setting	
Setting value	Alert mode name
12	Upper limit deviation alert with re-wait
13	Lower limit deviation alert with re-wait
14	Upper/lower limit deviation alert with re-wait

- If "Setting change rate limiter setting" is set in "Base Setting" and if using the slave during cascade control, alert with re-wait is not enabled.
- When "Setting change rate limiter setting" in "Base Setting" has been set, the value in 'CH1 Set value (SV) monitor' (Un\G406) follows the set value (SV) and gradually changes when the set value (SV) is changed. When it is supposed that the re-wait function is enabled under such a situation, the re-wait function would be always active, and an alert would not be output even while the temperature process value (PV) is not following the value in 'CH1 Set value (SV) monitor' (Un\G406). To prevent such cases, the re-wait function is disabled when a setting change rate limiter is used.

Setting alert modes and alert set values

The following describes the settings of alert modes and alert set values.

■Alert mode

Set alert modes.

Set "Alert 1 mode setting" to "Alert 4 mode setting" using the procedure described below. Up to 4 items can be set.

Alert modes of Alerts 1 to 4 correspond to the alert set values 1 to 4.

[Navigation window] ⇒ [Parameter] ⇒ Target module ⇒ [Module Parameter] ⇒ [Application Setting] ⇒ [Alert setting]

■Alert set value

Set the temperature at which CH1 Alert 1 (Un\G401, b8) to CH1 Alert 4 (Un\G401, b11) turn ON (1) according to the alert mode that has been selected. Up to 4 items can be set.

Set "Alert set value 1" to "Alert set value 4" using the following procedure.

Alert set values 1 to 4 correspond to the alert modes of Alert 1 to 4.

[Navigation window] ⇒ [Parameter] ⇒ Target module ⇒ [Module Parameter] ⇒ [Application Setting] ⇒ [Alert setting]

Setting an alert dead band

When the temperature process value (PV) or deviation (E) is close to the alert set value, the status may change repeatedly between the alert status and non-alert status due to inconsistent inputs.

In this case, by setting an alert dead band, repetition of the status change caused by inconsistent inputs can be prevented.

■Setting method

Configure the settings as described below.

[Navigation window] ⇒ [Parameter] ⇒ Target module ⇒ [Module Parameter] ⇒ [Application Setting] ⇒ [Alert setting] ⇒ [Alert dead band setting]

Ex.

When the alert mode has been set to "Upper Limit Input Alert"

When a value other than 0°C has been set for "Alert dead band setting" of "Alert setting" in "Application Setting", the system issues an alert when the input upper limit becomes equal to or greater than the alert set value. When the value becomes equal to or smaller than the alert dead band, the status changes to the non-alert status. (Lower right diagram)

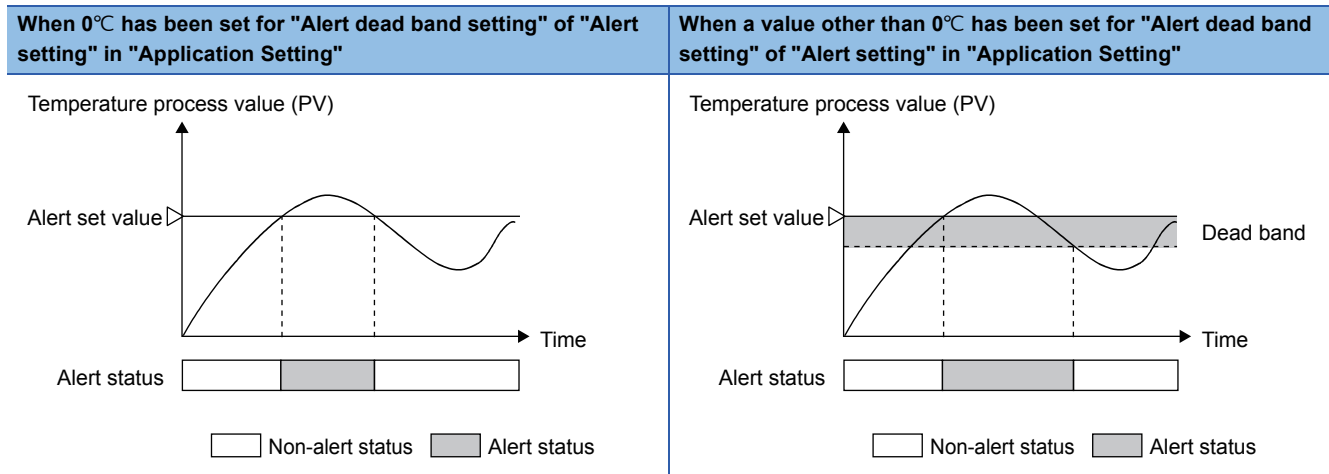

Setting the number of alert delays

Set the number of times to implement sampling to judge an alert. By setting the number of times to implement sampling, when the temperature process value (PV) stays within the alert range after the temperature process value (PV) has reached the alert set value until the number of times to implement sampling exceeds the number of alert delays, an alert occurs.

■ Setting method

Configure the settings as described below.

 [Navigation window] ⇒ [Parameter] ⇒ Target module ⇒ [Module Parameter] ⇒ [Application Setting] ⇒ [Alert setting] ⇒ [Number of alert delay]

Ex.

When the alert mode has been set to "Upper Limit Input Alert"

When 5 (times) is set as the number of alert delays, the system does not create an alert when the number of times to implement sampling is 4 times or less.

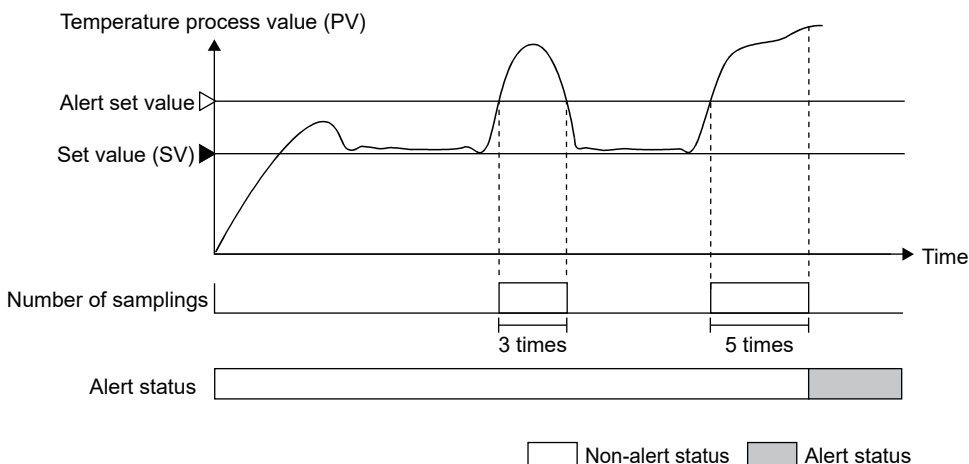

Alert mode and related settings

The following table shows the alert modes and the related settings described in this section.

Enabled or used: ○, disabled or not used: —

Alert		Alert dead band setting	Number of alert delay	Alert with wait	Alert with re-wait
Input alert	Upper limit input alert	○	○	○	—
	Lower limit input alert	○	○	○	—
Deviation alert	Upper limit deviation alert	○	○	○	○
	Lower limit deviation alert	○	○	○	○
	Upper/lower limit deviation alert	○	○	○	○
	Within-range alert	○	○	—	—

4.30 Loop Disconnection Detection Function

This function detects errors that occur in a control system (control loop) such as a load (heater) disconnection, an externally-operable device (such as a magnetic relay) error, and input disconnection.

How an error is detected

The variation amount of the temperature process value (PV) is monitored for each 'Loop disconnection detection judgment time' (Un\G537) from the time that control outputs were 0% (or the lower limit output limiter value) or less, or 100% (or the upper limit output limiter value) or greater to detect heater disconnections and input disconnections.

The loop disconnection detection area can be set using the loop disconnection detection dead band function.

Operation

The loop disconnection detection function operates as described below.

Operation	Manipulated amount is 0% (or the lower limit output limiter) or less	Manipulated amount is 100% (or the upper limit output limiter) or greater
Reverse Operation	An alert status occurs if the process value (PV) in the loop disconnection detection settings time does not fall to the loop disconnection detection judgment width or greater.*1	An alert status occurs if the process value (PV) in the loop disconnection detection settings time does not rise to the loop disconnection detection judgment width or greater.*1
Normal Operation	An alert status occurs if the process value (PV) in the loop disconnection detection settings time does not rise to the loop disconnection detection judgment width or greater.*1	An alert status occurs if the process value (PV) in the loop disconnection detection settings time does not fall to the loop disconnection detection judgment width or greater.*1

*1 If internal thermocouple/platinum resistance thermometer inputs selection= 2°C
 If internal micro voltage inputs selection= 0.2% of scaling span
 If external inputs selection= 0.2% of external inputs span

Setting method

Configure the settings as described below.

 [Navigation window] ⇒ [Parameter] ⇒ Target module ⇒ [Module Parameter] ⇒ [Application Setting] ⇒ [Loop disconnection detection setting]

Point

- When this function is not necessary, set 0 for "Loop disconnection detection judgment time" of "Loop disconnection detection setting" in "Application Setting".
- During auto tuning, the loop disconnection detection settings does not operate.
- During heating and cooling PID control, the loop disconnection detection settings does not operate.

4.31 Loop Disconnection Detection Dead Band Function

Set the non-alert area having the set value (SV) at the center (temperature width in which no loop disconnection is detected) to prevent accidental alerts of the loop disconnection detection.

When the temperature process value (PV) is within the loop disconnection detection dead band, an alert is not output even though the loop disconnection alert conditions have been satisfied.

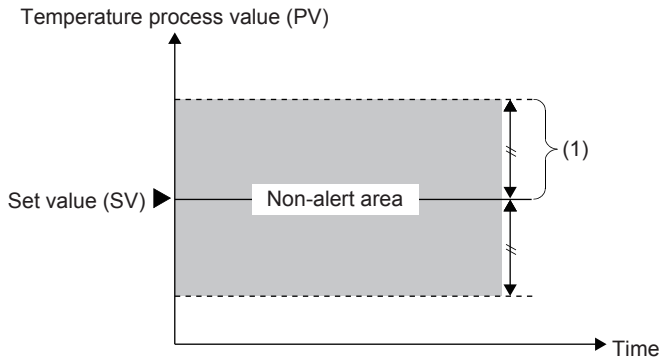

(1) 'CH1 Loop disconnection detection dead band' (Un\G538) (this band has the set value (SV) at the center)^{*1}

- *1 If internal thermocouple/platinum resistance thermometer inputs selection= 0.8°C
- If internal micro voltage inputs selection= 0.8% of scaling span
- If external inputs selection= 0.8% of external inputs span

Setting method

Configure the settings as described below.

[Navigation window] ⇒ [Parameter] ⇒ Target module ⇒ [Module Parameter] ⇒ [Application Setting] ⇒ [Loop disconnection detection setting] ⇒ [Loop disconnection detection dead band]

Point

When this function is not necessary, set 0 for "Loop disconnection detection dead band" of "Loop disconnection detection setting" in "Application Setting".

4.32 Heater Disconnection Detection Function

When a transistor output is ON, this function checks whether or not a heater has a disconnection using the Heater current process value (load current value detected by a current sensor (CT)). This function compares the heater current process value and the heater disconnection alert current value. When the Heater current process value becomes equal to or smaller than the heater disconnection alert current value, the heater is regarded as having a disconnection. However, when the transistor-output ON time is 220 ms or less, no heater disconnection is detected. (CH1 Heater disconnection detection (Un\G401, b12) remains OFF.)

The timing when an alert is output is described below.

- 500 ms \times n

n = Value set for "Heater disconnection/output OFF-time current error detection delay count" of "Loop disconnection detection setting" in "Application Setting"

When the heater disconnection status lasts longer than the time described above, the following operations are implemented.

- 'CH1 alert ON flag' (Un\G398, b12) turns ON (1).
- 'CH1 Heater disconnection detection' (Un\G401, b12) turns ON (1).
- CH□ heater disconnection detection (alarm code: 088□) is stored in 'Latest alarm code' (Un\G3).

Setting method

Configure the settings as described below.

1. Set the judgment value for heater disconnection detection in "Heater disconnection alert settings" in "Loop disconnection detection settings" in "Application Setting".

 [Navigation window] \Rightarrow [Parameter] \Rightarrow Target module \Rightarrow [Module Parameter] \Rightarrow [Application Setting] \Rightarrow [Heater disconnection detection setting]

2. Set how many times heater disconnections are detected successively to regard the heater as disconnected for "Heater disconnection/output OFF-time current error detection delay count" of "Heater disconnection detection setting" in "Application Setting".

4.33 Output OFF-time Current Error Detection Function

Transistor output errors can be detected using this function. A current sensor (CT) for heater disconnection detection is used to check for errors of when transistor outputs are OFF.

A Heater current process value and the heater disconnection alert current value are compared. If the Heater current process value is larger than the heater disconnection alert current value, an output OFF-time current error occurs.

Detection of output OFF-time current errors is implemented every 500 ms. When the OFF time of a transistor output has been set as 220 ms below, output OFF-time current errors are not detected. (CH1 Output OFF-time current error (Un\G401, b14) remains OFF (0).)

The timing when an alert is output is described below.

- 500 ms \times n

n = Value set for "Heater disconnection/output OFF-time current error detection delay count" of "Loop disconnection detection setting" in "Application Setting"

When the output OFF-time current error status lasts longer than the time described above, the following operations are implemented.

- 'CH1 alert ON flag' (Un\G398, b12) turns ON (1).
- 'CH1 Output OFF-time current error' (Un\G401, b14) turns ON (1).
- Current error detection when CH□ outputs are OFF (alarm code: 08A□) is stored in 'Latest alarm code' (Un\G3).

Setting method

Configure the settings as described below.

1. Set the judgment value for current error detection when outputs are OFF in "Heater disconnection alert settings" in "Loop disconnection detection settings" in "Application Setting".

[Navigation window] ⇨ [Parameter] ⇨ Target module ⇨ [Module Parameter] ⇨ [Application Setting] ⇨ [Heater disconnection detection setting]

2. Set how many times current errors while outputs are OFF are detected successively to regard a current error while outputs are OFF as having occurred in "Heater disconnection/output OFF-time current error detection delay count" of "Heater disconnection detection setting" in "Application Setting".

4.34 Buffer Memory Data Backup Function

This function backs up data in buffer memory areas to the non-volatile memory.

The backed up data is transferred from the non-volatile memory to the buffer memory when the power is turned OFF→ON or the CPU module is reset. Consequently, when the power supply is turned OFF→ON and the CPU module is reset, temperatures can be adjusted even if no data has been written.

Target buffer memory

Refer to the list of buffer memory allocations. (☞ Page 99 List of buffer memory addresses)

To write data to the non-volatile memory, turn OFF and ON 'Setting value backup command' (Un\G399, b8).

When writing the data to the non-volatile memory is completed, 'Setting value backup completion flag' (Un\G398, b8) turns ON.

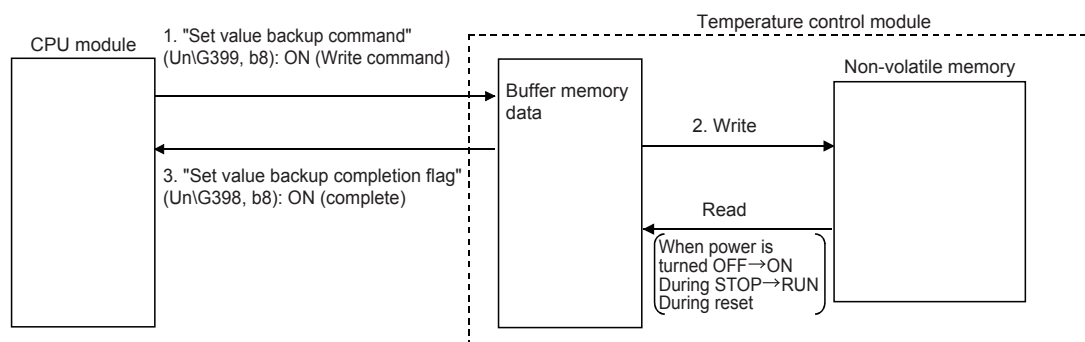

If writing the data to the non-volatile memory is not completed successfully, 'Setting value backup failure flag' (Un\G398, b10) turns ON.

■Setting change

Change the settings of the buffer memory areas while 'Setting value backup completion flag' (Un\G398, b8) is OFF.

■Reading data from the non-volatile memory

Reading is enabled when the power supply is turned OFF→ON and the CPU module is reset.

■Precautions following implementation of the set value backup function

When the power supply is turned OFF→ON and the CPU module is reset after this function is implemented, the data transferred to buffer memory is overwritten by the GX Works3 parameter settings.

To use the set values stored as the backup data of the initial settings of the module, implement one of the following actions.

- Do not set GX Works3 parameters
- When configuring the parameter setting of GX Works3, correct the set values of the parameters to the ones stored as backup data, and write the parameters to the CPU module

4.35 Default Function

The data type initializes the "settings" buffer memory.
For the types of buffer memory, refer to the following.

☞ Page 99 List of buffer memory addresses

Setting method

Set in the following buffer memory area.

- Default setting registration command (Un\G399, b9) (☞ Page 127 Default setting registration command (b9))

Precautions

- In normal mode, control mode selection and auto settings during input range changes, output signal are not initialized.
- Not initialized during control or implementation of the buffer memory data backup function.

4.36 Error History Function

The errors or alarms that occurred in the temperature control module are stored in the buffer memory as history. A maximum 16 of both errors and alarms can be stored.

Operation

When errors occur, error codes and error times of the errors are stored in 'Error history No.1' (Un\G3600 to Un\G3609) in order.

When alarms occur, alarm codes and alarm times of the alarms are stored in 'Alarm history No.1' (Un\G3760 to Un\G3769) in order.

- Error code allocation details

	b15	to	b8 b7	to	b0
Un\G3600	Error code				
Un\G3601	First 2 digits of date		Last 2 digits of date		
Un\G3602	Month		Day		
Un\G3603	Time		Minute		
Un\G3604	Second		Day of the week		
Un\G3605	Millisecond (upper)		Millisecond (lower)		
Un\G3606	System area				
:					
Un\G3609					

- Alarm code allocation details

	b15	to	b8 b7	to	b0
Un\G3760	Alarm code				
Un\G3761	First 2 digits of date		Last 2 digits of date		
Un\G3762	Month		Day		
Un\G3763	Time		Minute		
Un\G3764	Second		Day of the week		
Un\G3765	Millisecond (upper)		Millisecond (lower)		
Un\G3766	System area				
:					
Un\G3769					

Ex.

Storage example of error history and alarm history data

Item	Stored contents	Storage example*1
First two digits of the year/last two digits of the year	Stored in BCD code.	2015H
Month/day		131H
Hour/minute		1234H
Second		56H
Day of the week	One of the following values is stored in BCD code. Sunday: 0, Monday: 1, Tuesday: 2, Wednesday: 3 Thursday: 4, Friday: 5, Saturday: 6	6H
Millisecond (upper)	Stored in BCD code.	7H
Millisecond (lower)		89H

*1 Value stored when an error occurs at 12:34:56.789 on Saturday, January 31, 2015

The start address of the error history where the latest error has been stored can be checked in 'Latest address of error history' (Un\G2).

The start address of the alarm history where the latest alarm has been stored can be checked in 'Latest address of alarm history' (Un\G4).

Ex.

When the third error occurred

The third error is stored in Error history No. 3 and 3620 (the start address of Error history No.3) is stored in 'Latest address of error history' (Un\G2).

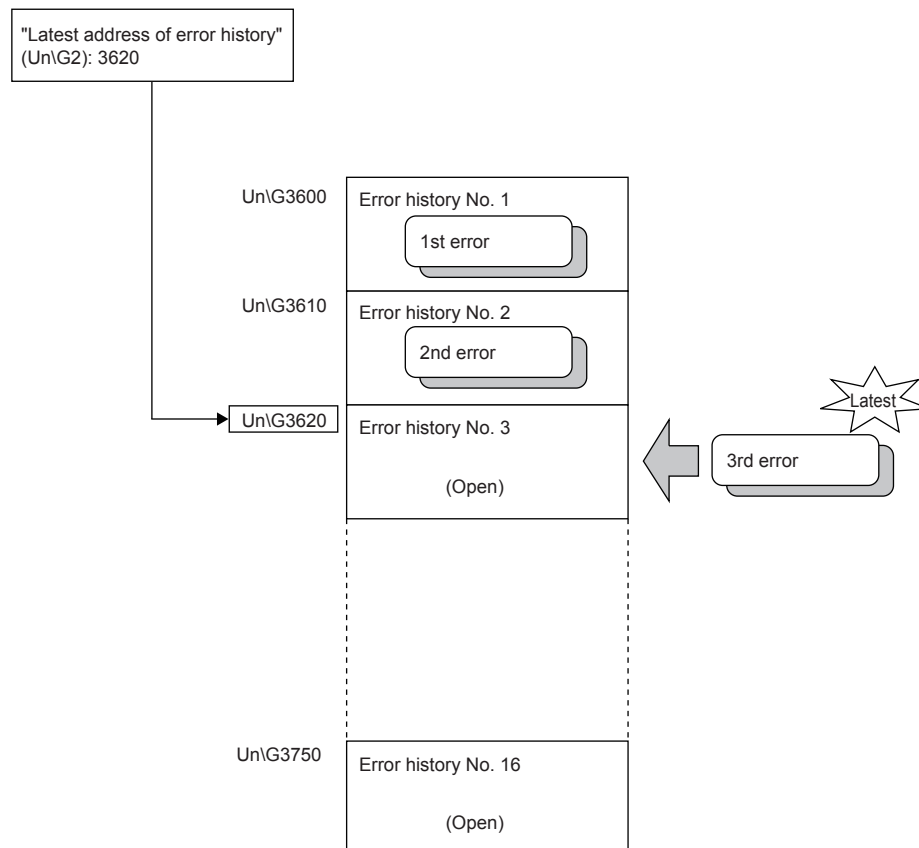

Ex.

When the 17th error occurred

The 17th error is stored in Error history No. 17 and 3600 (the start address of Error history No. 1) is stored in 'Latest address of error history' (Un\G2).

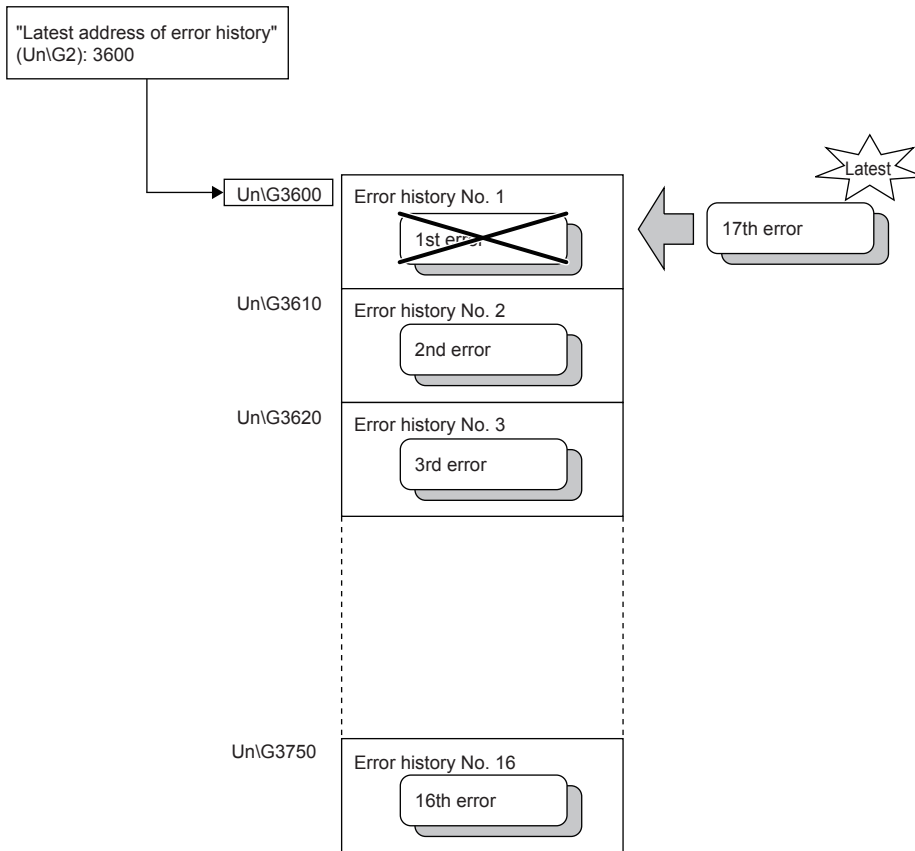

Point

- When the storage areas for the error history are full, data in 'Error history No.1' (Un\G3600 to Un\G3609) is overwritten in order and recording of error history continues. The history data before the data overwriting is deleted.
- The same process is implemented in the alarm history.
- The registered error history is cleared by turning OFF of the temperature control module or resetting the CPU module.

4.37 FX3 Allocation Mode Function

The temperature control module buffer memory addresses can be arranged in the same way as for FX3U-4LC. Sequence programs proven with the FX3U-4LC can be used.

Operation

In FX3 allocation mode, broad program corrections are not required during FX3 program appropriation as the buffer memory allocations are the same as for FX3U-4LC.

Further, in FX3 allocation mode, the temperature adjustment settings can be set from the parameters.

Setting method

Configure the settings as described below.

1. When adding a new module, select a module whose name has "(FX3)" after its module model name.

 [Navigation] ⇒ [Parameter] ⇒ [Module Information] ⇒ Right-click ⇒ [Add New Module]

2. Set parameters in the same way as in normal mode.
3. Write the parameters to the module, and then either reset or turn OFF→ON the power supply.

Restriction

- It is not possible to switch between normal mode and FX3 allocation mode during operations.
 - "Temperature control trace" in the module tools is not compatible with FX3 allocation mode.
-

5 SYSTEM CONFIGURATION

5.1 Overall Configuration

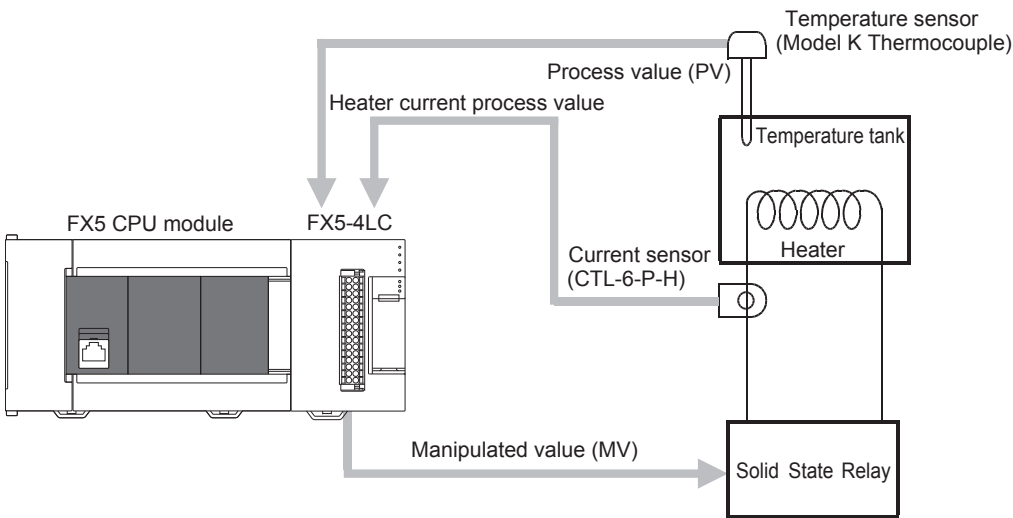

Temperature sensor

For details on the usable temperature sensors, refer to the following.

☞ Page 16 SPECIFICATIONS

Current sensor (CT)

Usable current sensors (CT) are described below.

Model	Inquiries
CTL-12-S36-8 (0.0 to 100.0 A)	U.R.D. Co., Ltd.
CTL-12-S36-10 (0.0 to 100.0 A)	
CTL-12-S56-10 (0.0 to 100.0 A)	
CTL-12L-8 (0.0 to 100.0 A)	
CTL-6-P (0.0 to 30.0 A)	
CTL-6-P-H (0.0 to 30.0 A)	
CTL-6-S-H (0.0 to 30.0 A)	

For details on the current sensors (CT) selection, refer to the following.

☞ Page 63 Heater Disconnection Detection Function

6 WIRING

This section explains the temperature control module wiring.

6.1 Spring Clamp Terminal Block

Suitable wiring

The wires to connect the spring clamp terminal block are described below.

No. of wire per terminal	Wire size	
	Single wire, Strand wire	Ferrule with insulation sleeve
One wire	AWG24 to 16 (0.2 to 1.5 mm ²)	AWG23 to 19 (0.25 to 0.75 mm ²)

Wire end treatment

When not using a ferrule, strip the cable about 10 mm from the tip and connect it as a strand wire so that the wires do not separate. When using a ferrule, strip the cable about 10 mm from the tip to connect a wire ferrule at the striped area. Failure to do so may result in electric shock or short circuit between adjacent terminals because of the conductive part. If the wire strip length is too short, it may result in the unstable connection to the spring clamp terminal part.

Depending on the thickness of the sheath, it may be difficult to insert into the insulation sleeve, so select the wires by referring to the specifications in the diagram.

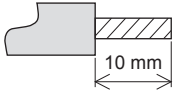
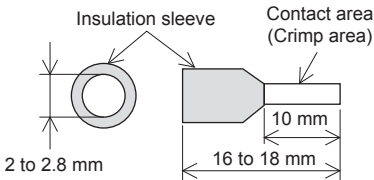
Strand wire/single wire	Ferrule with insulation sleeve
	

The following table shows wire ferrules and tools for wire ferrules compatible with the terminal block. Use of items other than these may result in not being able to remove the wire ferrule, so carefully check that the wire ferrule can be unplugged.

<Reference product>

Manufacturer	Model	Wire size	Crimp tool
PHOENIX CONTACT GmbH & Co. KG	AI 0.5-10 WH	0.5 mm ²	CRIMPFOX 6
	AI 0.75-10 GY	0.75 mm ²	
	A 1.0-10	1.0 mm ²	
	A 1.5-10	1.5 mm ²	

Connecting a cable

■When ferrules with insulation sleeve are used

Insert a wire with the ferrule with insulation sleeve into the wire insertion opening and push the wire.

■When stranded wires and solid wires are used

Push the open/close button of the terminal block with a flathead screwdriver. While pushing the open/close button, insert the wire into the insertion opening until the wire reaches the back, and then release the open/close button.

<Reference>

Manufacturer	Model
PHOENIX CONTACT GmbH & Co. KG	SZS 0.4×2.5 VDE

Precautions

Then, pull the wire lightly and check that it is clamped securely.

Disconnecting a cable

Push the open/close button of the wire to be disconnected with a flathead screwdriver. Pull out the wire with the open/close button pushed.

6.2 Terminals Layout

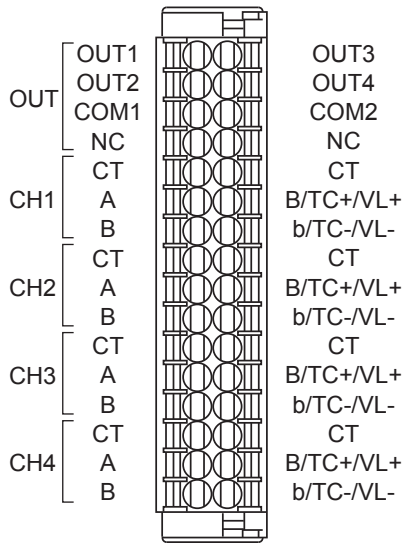

Terminal name		Description
OUT	OUT1	CH1 Transistor output (Control outputs, alert outputs)
	OUT2	CH12 Transistor output (Control outputs, alert outputs)
	COM1	COM for OUT1 and OUT2
	NC	—
	OUT3	CH3 Transistor output (Control outputs, alert outputs)
	OUT4	CH4 Transistor output (Control outputs, alert outputs)
	COM2	COM for OUT3 and OUT4
	NC	—
CH1	CT	CT input
	A	Platinum resistance thermometer A inputs
	B	Short-circuit this terminal and b when using 2-wire platinum resistance thermometer
	CT	CT input
	B/TC+/VL+	Platinum resistance thermometer B/thermocouple + /low-voltage VL + inputs
	b/TC-/VL-	Platinum resistance thermometer b/thermocouple - /low-voltage VL - inputs
CH2	CT	CT input
	A	Platinum resistance thermometer A inputs
	B	Short-circuit this terminal and b when using 2-wire platinum resistance thermometer
	CT	CT input
	B/TC+/VL+	Platinum resistance thermometer B/thermocouple + /low-voltage VL + inputs
	b/TC-/VL-	Platinum resistance thermometer b/thermocouple - /low-voltage VL - inputs
CH3	CT	CT input
	A	Platinum resistance thermometer A inputs
	B	Short-circuit this terminal and b when using 2-wire platinum resistance thermometer
	CT	CT input
	B/TC+/VL+	Platinum resistance thermometer B/thermocouple + /low-voltage VL + inputs
	b/TC-/VL-	Platinum resistance thermometer b/thermocouple - /low-voltage VL - inputs
CH4	CT	CT input
	A	Platinum resistance thermometer A inputs
	B	Short-circuit this terminal and b when using 2-wire platinum resistance thermometer
	CT	CT input
	B/TC+/VL+	Platinum resistance thermometer B/thermocouple + /low-voltage VL + inputs
	b/TC-/VL-	Platinum resistance thermometer b/thermocouple - /low-voltage VL - inputs

6.3 Power Supply Wiring

Power connector layout

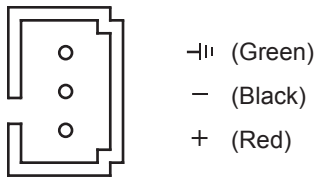

Power supply wiring

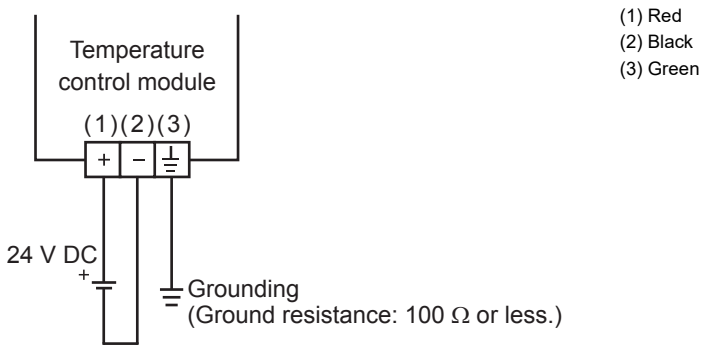

Grounding

Perform the following.

- Perform class D grounding (Grounding resistance: 100 Ω or less).
- Ground the programmable controller independently when possible.
- If the programmable controller cannot be grounded independently, perform the "Shared grounding" shown below.

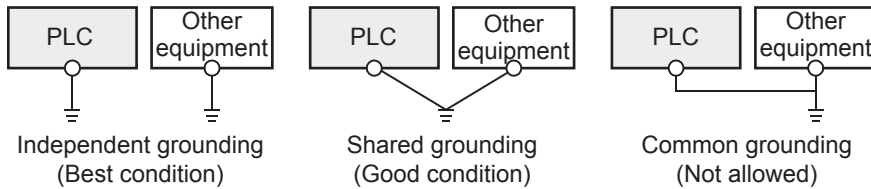

- Bring the grounding point close to the PLC as much as possible so that the ground cable can be shortened.

6.4 External Wiring Example

An external wiring example is shown below.

Thermocouple

For thermocouples usable with the temperature control module, refer to Page 17 Input specifications.

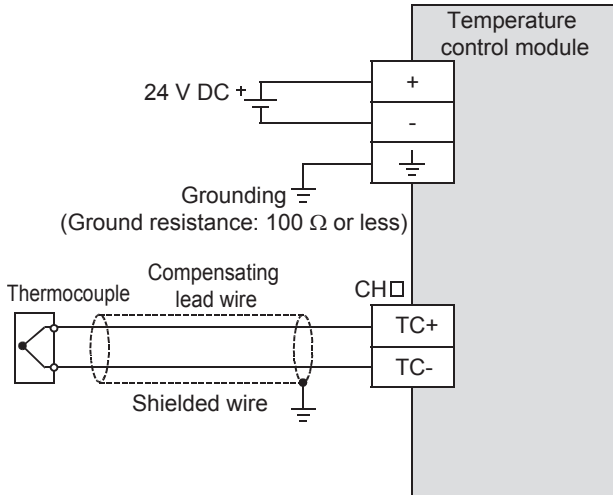

CH□: represents the channel number.

Precautions

When using a thermocouple, use specified compensating lead wires.

Resistance thermometer

For resistance thermometer usable with the temperature control module, refer to Page 17 Input specifications.

Pt100 (3-wire type) or Pt1000 (3-wire type)	Pt1000 (2-wire type)
<p>CH□: represents the channel number.</p>	<p>CH□: represents the channel number.</p>

Precautions

- When using a resistance thermometer, use lead wires of equal, low resistance.
- Make sure to short-circuit the [B] and [b] terminals when a 2-wire resistance thermometer is input.

Micro voltage input

For the micro voltage input range usable with the temperature control module, refer to  Page 17 Input specifications.

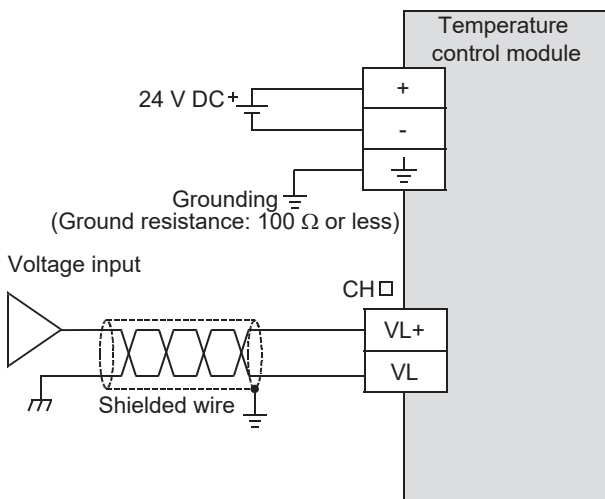

CH□: represents the channel number.

Outputs wiring example

Internal transistor outputs are NPN open collector transistor outputs.

For output specifications, refer to  Page 19 Output specifications.

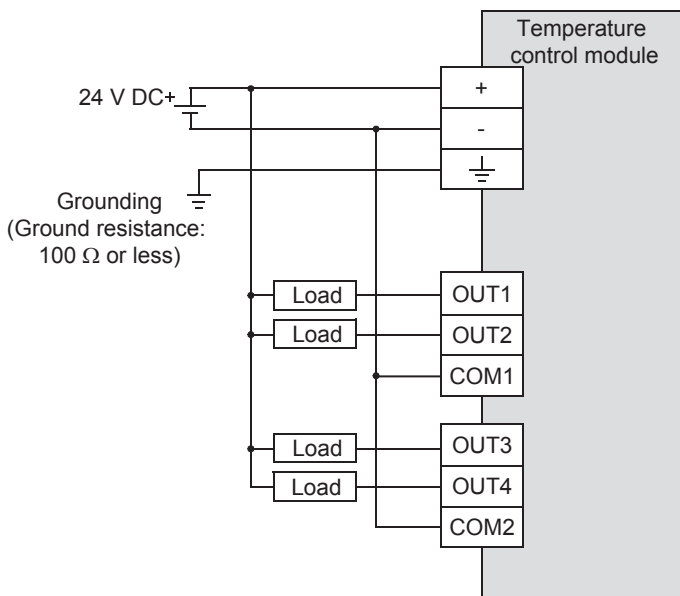

Current detector (CT) wiring example

For current detector, refer to [Page 18](#) Current detector (CT) input specifications.

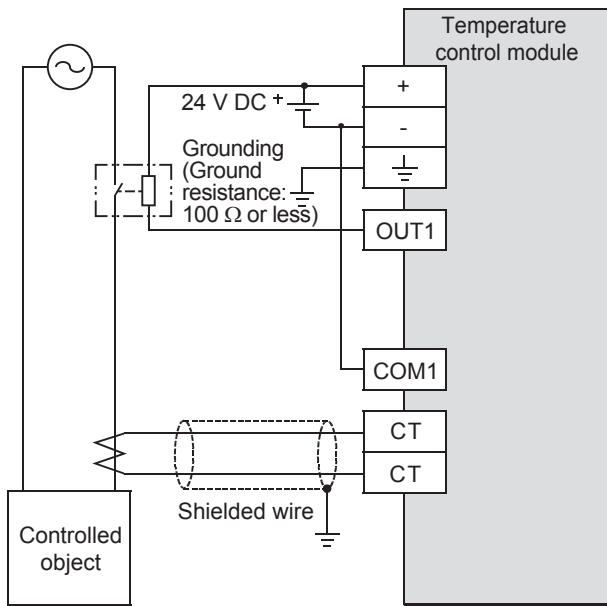

7 PARAMETER SETTING

Set the parameters of each channel.

By setting parameters, the parameter setting by program is not needed.

Point

When adding a temperature control module, FX3 allocation mode is usable if a module with the suffix "(FX3)" after its name is selected.

- FX5-4LC: Normal mode
- FX5-4LC (FX3): FX3 allocation mode

This chapter describes normal mode.

7.1 Base Setting

Setting method

1. Configure the settings in "Base Setting" of the engineering tool.

[Navigation window] ⇒ [Parameter] ⇒ [Module Information] ⇒ Target module ⇒ [Module Parameter] ⇒ [Base Setting]

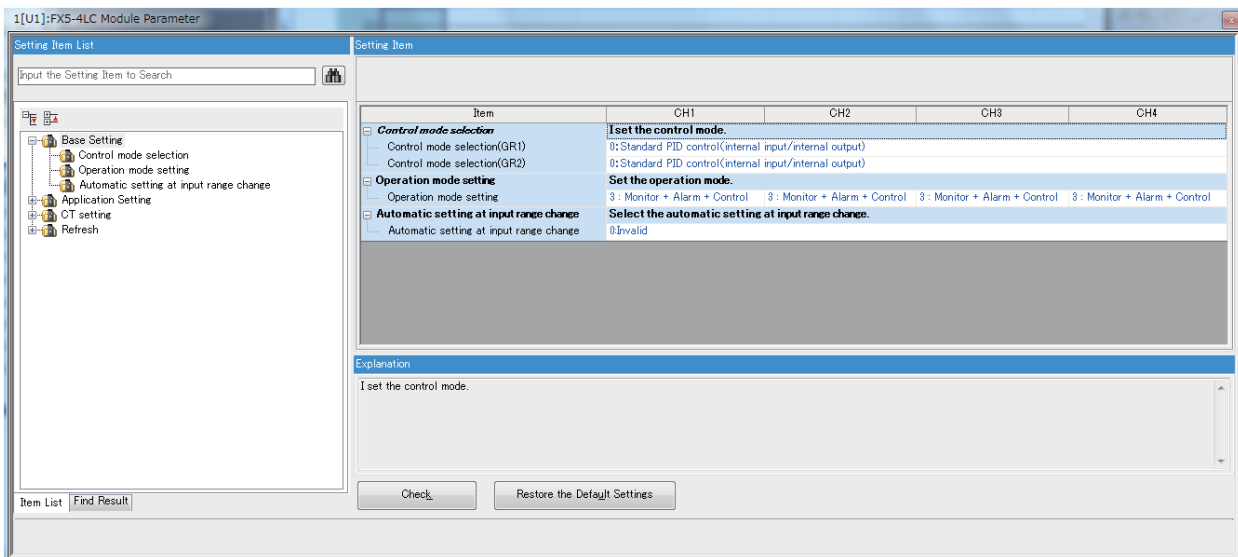

2. Double-click the item to change the setting, and enter a set value.

- Items where a value is selected from a drop-down list

Clicking the [▼] button of the item to be set displays the drop-down list. Select the item.

- Items where a value is entered into a text box

Double-click the item to be set, and enter a value.

7.2 Application Setting

Setting method

1. Configure the settings in "Application Setting" of the engineering tool.

[Navigation window] ⇒ [Parameter] ⇒ [Module Information] ⇒ Target module ⇒ [Module Parameter] ⇒ [Application Setting]

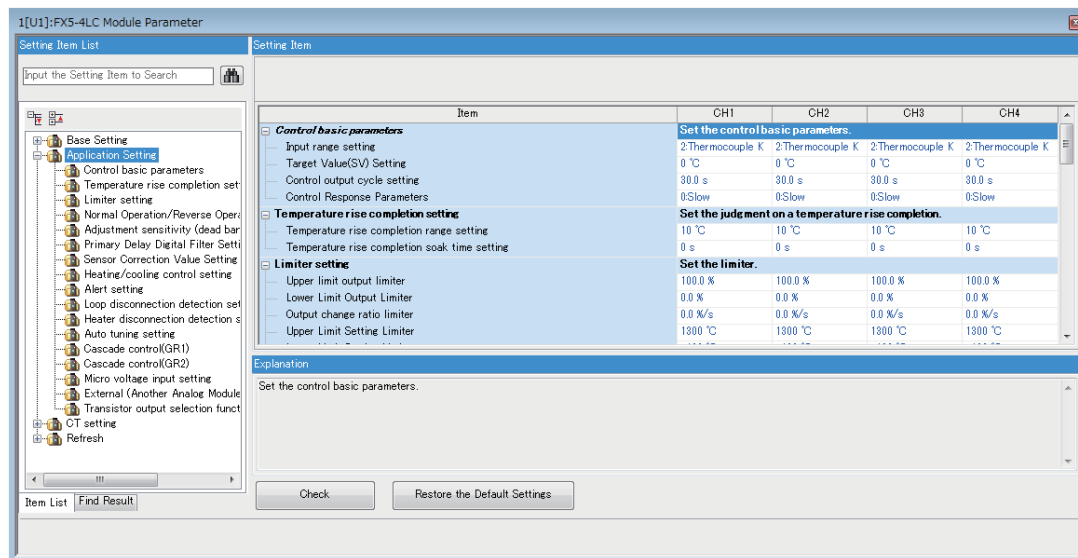

2. Double-click the item to change the setting, and enter a set value.

- Items where a value is selected from a drop-down list

Clicking the [▼] button of the item to be set displays the drop-down list. Select the item.

- Items where a value is entered into a text box

Double-click the item to be set, and enter a value.

7.3 CT Setting

Setting method

1. Configure the settings in "CT setting" of the engineering tool.

[Navigation window] ⇒ [Parameter] ⇒ [Module Information] ⇒ Target module ⇒ [Module Parameter] ⇒ [CT setting]

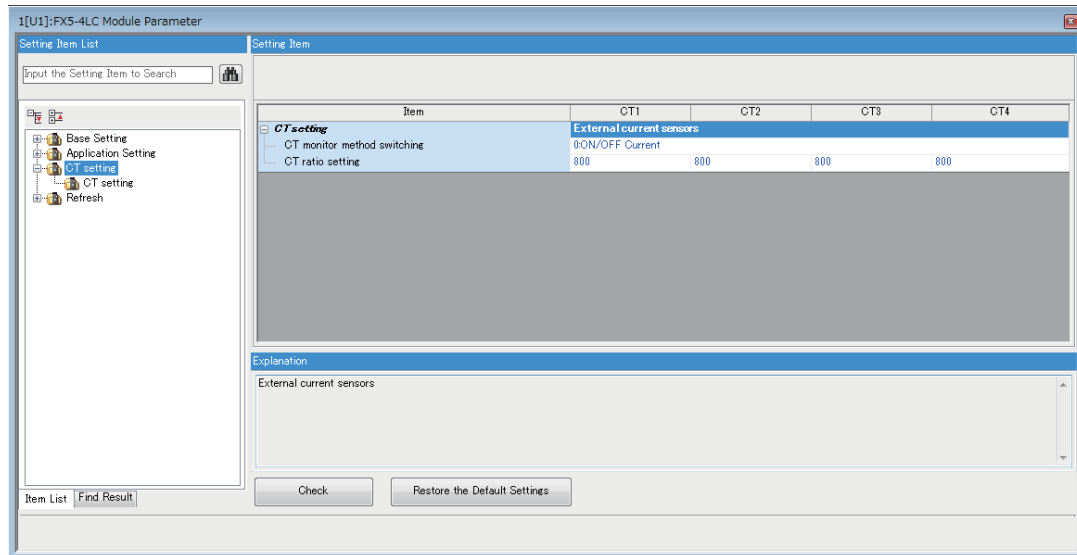

2. Double-click the item to change the setting, and enter a set value.

- Items where a value is selected from a drop-down list

Clicking the [▼] button of the item to be set displays the drop-down list. Select the item.

- Items where a value is entered into a text box

Double-click the item to be set, and enter a value.

7.4 Refresh Setting

Setting method

Set the buffer memory areas of the temperature control module to be automatically refreshed. Configuring the refresh settings eliminates the need of a program for reading/writing data.

1. Start parameters.

[Navigation window] ⇒ [Parameter] ⇒ [Module Information] ⇒ Target module ⇒ [Module Parameter] ⇒ [Refresh]

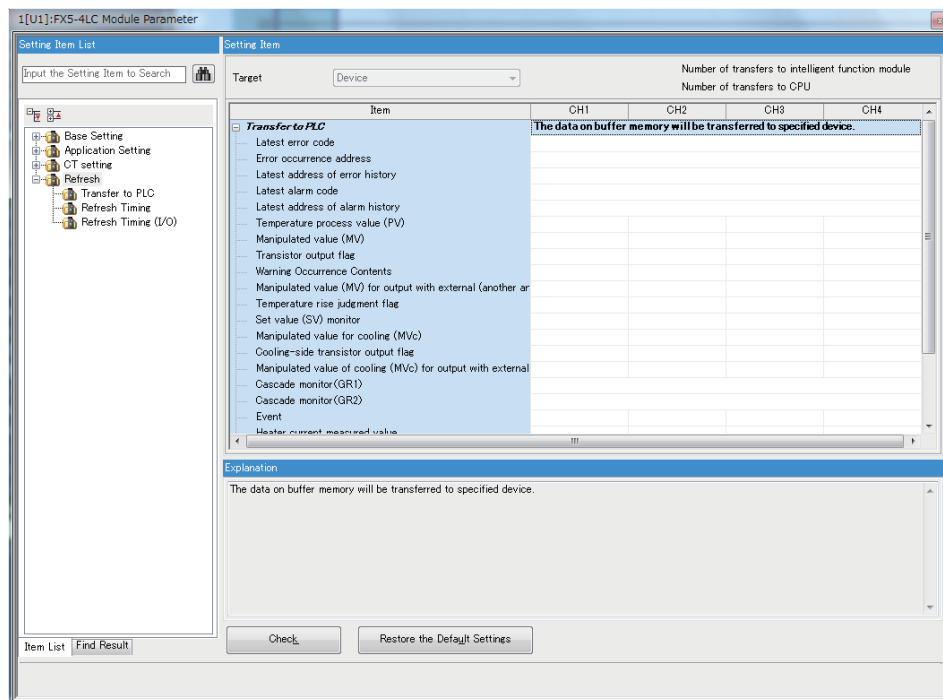

2. Double-click the item to be set, and enter a value.

8 PROGRAMMING

This section explains the temperature control module programming procedures and basic programs.

8.1 Programming Procedure

Create a program to implement the temperature control module using the following procedure.

1. Set the parameters.
2. Create the program.

Standard PID control

System configuration

A system configuration example is described below.

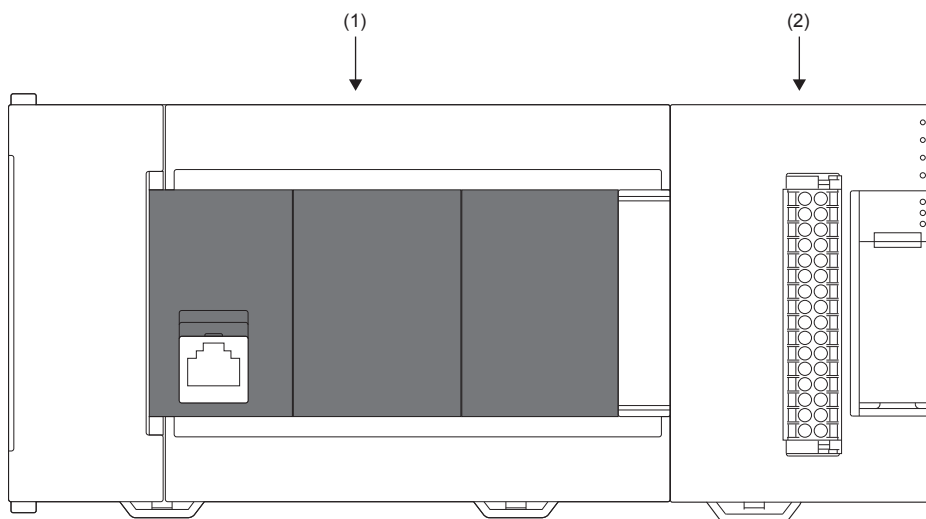

- (1) CPU module (FX5U CPU module)
(2) Temperature control module (FX5-4LC)

Parameter settings

Connect GX Works3 to the CPU module to set the parameters.

Point

In the program example, default parameters are used for the parameters that have not been set. For the parameters, refer to the following.

☞ Page 77 PARAMETER SETTING

■Setting modules

1. Set the CPU module as described below.

☞ [Project] ⇒ [New]

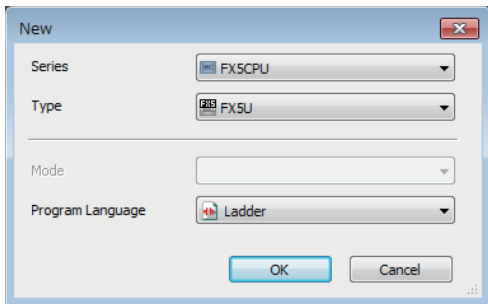

2. Click the [OK] button as shown below.

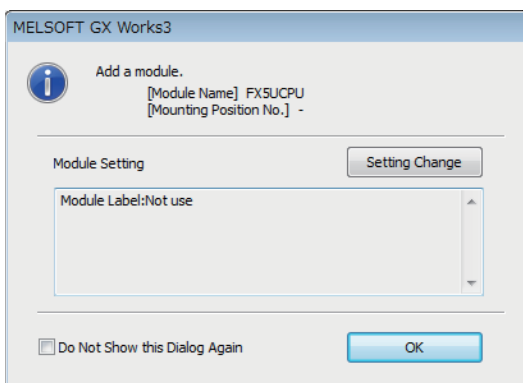

3. Set FX5-4LC as described below.

☞ [Navigation] ⇒ [Parameter] ⇒ [Module Information] ⇒ Right-click ⇒ [Add New Module]

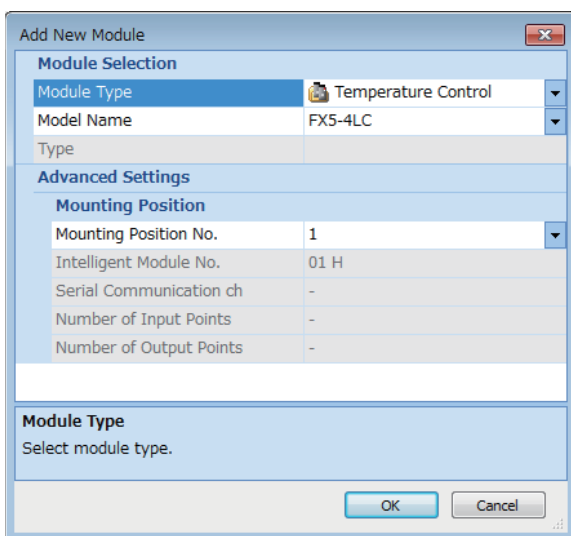

4. Click the [OK] button as shown below.

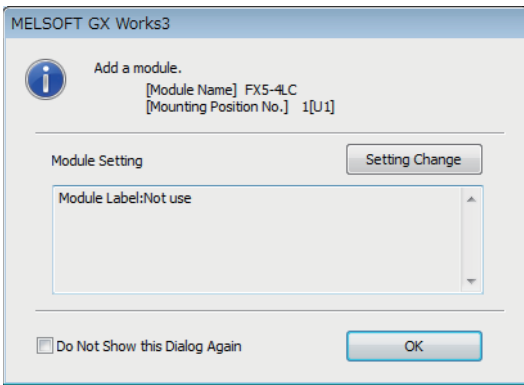

■Setting temperature control module parameters

1. Set the "Base Setting" contents as described below.

[Navigation window] ⇒ [Parameter] ⇒ [Module Information] ⇒ [FX5-4LC] ⇒ [Module Parameter] ⇒ [Base Setting]

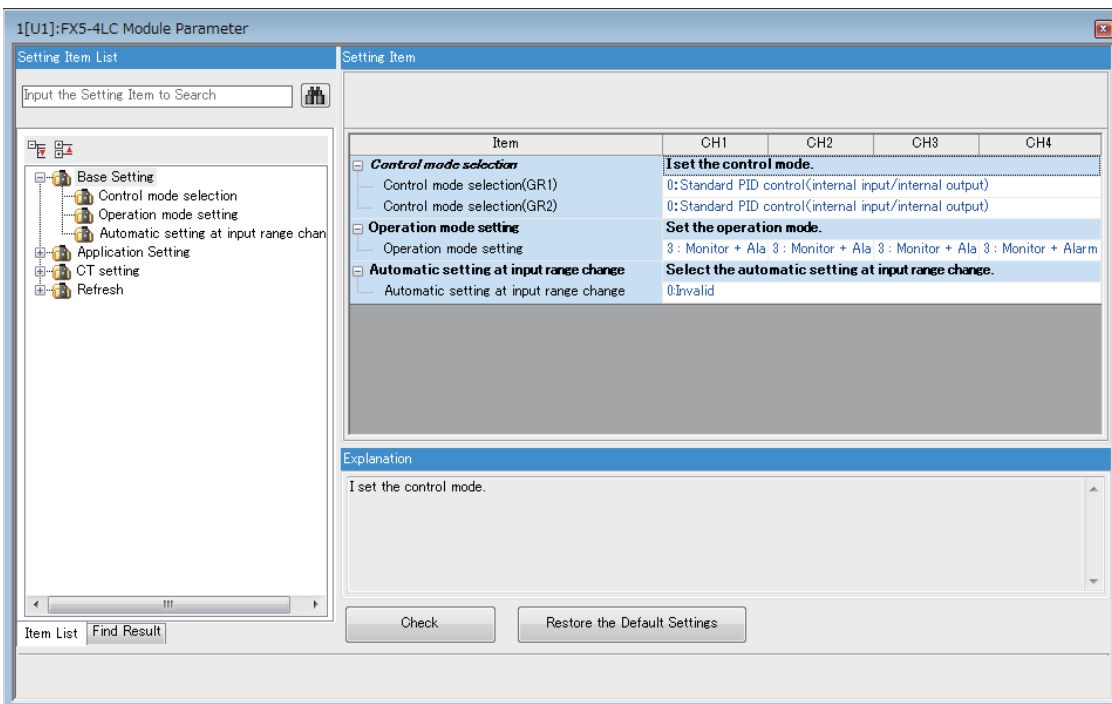

2. Set the "Application Setting" contents as described below.

[Navigation window] ⇒ [Parameter] ⇒ [Module Information] ⇒ [FX5-4LC] ⇒ [Module Parameter] ⇒ [Application Setting]

- "Control basic parameters"

Set the CH1 "Target Value (SV) Setting" as shown in the diagram below.

Item	CH1	CH2	CH3	CH4
Control basic parameters	Set the control basic parameters.			
Input range setting	2:Thermocouple 2:Thermocouple 2:Thermocouple 2:Thermocouple K M			
Target Value(SV) Setting	200 °C	0 °C	0 °C	0 °C
Control output cycle setting	30.0 s	30.0 s	30.0 s	30.0 s
Control Response Parameters	0:Slow	0:Slow	0:Slow	0:Slow

- "Limiter setting"

Set the CH1 "Upper Limit Setting Limiter" as shown in the diagram below.

Item	CH1	CH2	CH3	CH4
Limiter setting	Set the limiter.			
Upper limit output limiter	100.0 %	100.0 %	100.0 %	100.0 %
Lower Limit Output Limiter	0.0 %	0.0 %	0.0 %	0.0 %
Output change ratio limiter	0.0 %/s	0.0 %/s	0.0 %/s	0.0 %/s
Upper Limit Setting Limiter	400 °C	1300 °C	1300 °C	1300 °C
Lower Limit Setting Limiter	-100 °C	-100 °C	-100 °C	-100 °C
Setting change rate limiter	0.0 %	0.0 %	0.0 %	0.0 %

- "Alert setting"

Set the CH1 "Alert 1 mode setting" and "Alert set value 1" as shown in the diagram below.

Item	CH1	CH2	CH3	CH4
Alert setting	Set the temperature process value (PV) or alert status of the device.			
Alert 1 mode setting	1:Upper limit input	0:Not Warning	0:Not Warning	0:Not Warning
Alert 2 mode setting	0:Not Warning	0:Not Warning	0:Not Warning	0:Not Warning
Alert 3 mode setting	0:Not Warning	0:Not Warning	0:Not Warning	0:Not Warning
Alert 4 mode setting	0:Not Warning	0:Not Warning	0:Not Warning	0:Not Warning
Alert set value 1	250 °C	0 °C	0 °C	0 °C
Alert set value 2	0 °C	0 °C	0 °C	0 °C
Alert set value 3	0 °C	0 °C	0 °C	0 °C
Alert set value 4	0 °C	0 °C	0 °C	0 °C
Alert dead band setting	1.0 %	1.0 %	1.0 %	1.0 %
Number of alert delay	0 Times	0 Times	0 Times	0 Times



Use the default values for parameters not described above.

■ Writing to the CPU module

1. Write the set parameters to the CPU module, and then either reset the CPU module or turn OFF→ON the power supply.

[Online] ⇒ [Write to PLC]

Auto tuning

Implement auto tuning.

 [Tool] ⇒ [Module Tool List]

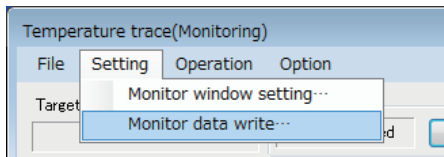
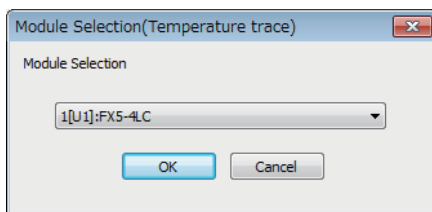
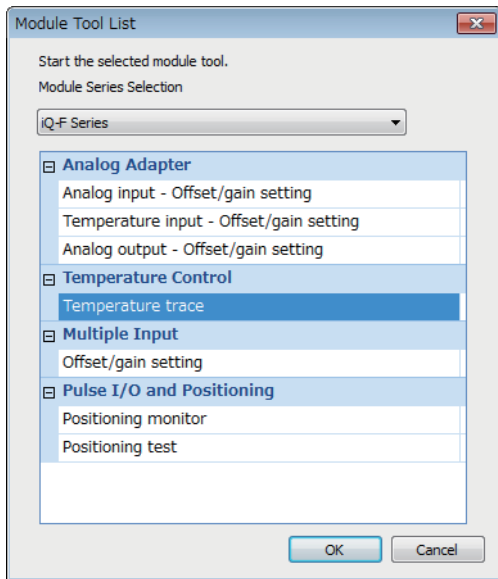

Name	CH1	CH2	CH3	CH4
Control command				
Setting/Operation mode command	1:Operation mode command			
Setting/Operation mode status	1:Operation mode			
Auto tuning command	1:ON	0:OFF	0:OFF	0:OFF
Auto tuning status	Executing	Stopped	Stopped	Stopped
Setting value back up command	0:OFF			
Setting value back up completed fla	0:OFF			
AUTO/MAN mode shift	0:AUTO	0:AUTO	0:AUTO	0:AUTO

Name	CH1	CH2	CH3	CH4
Control command				
Setting/Operation mode command	1:Operation mode command			
Setting/Operation mode status	1:Operation mode			
Auto tuning command	1:ON	0:OFF	0:OFF	0:OFF
Auto tuning status	Stopped	Stopped	Stopped	Stopped
Setting value back up command	0:OFF			
Setting value back up completed fla	0:OFF			
AUTO/MAN mode shift	0:AUTO	0:AUTO	0:AUTO	0:AUTO

1. Select "Temperature trace" in "Temperature Control Module" and click the [OK] button.

2. Select FX5-4LC, and click the [OK] button.

3. Select "Monitor data write" from the items described below.

 [Setting] ⇒ [Monitor data write]

4. Set "Setting/Operation mode command" to "1: Operation mode command".

5. Set "Auto tuning command" to "1: ON".

6. Set "Auto tuning command" to "1: ON", "Auto tuning status" becomes "Implementing" and the auto tuning starts.

7. When the auto tuning is completed, "Auto tuning status" becomes "Stopped".

8. The temperature control is implemented with the set PID constants.

Program example

Classification	Label Name	Description	Device
Module label	FX5LC_1.stOutput_D.bSettingChangeCommand_D	Setting change command	U1\G399, b11
	FX5LC_1.stOutput_D.bSettingOperationModeCommand_D	Setting/operation mode command	U1\G399, b1
	FX5LC_1.stInput_D.bModuleREADY_D	Module ready flag	U1\G398, b0
	FX5LC_1.stnMonitor_Ch_D[0].uAlertDefinition_D.8	CH1 Alert definition	U1\G401, b8
	FX5LC_1.stnMonitor_Ch_D[0].wTemperatureProcessValue_D	CH1 Temperature process value (PV)	U1\G402
	FX5LC_1.stErrorInfo_D.uErrorOccurrenceAddress_D	Error occurrence address	U1\G1
	FX5LC_1.stErrorInfo_D.uLatestErrorCode_D	Latest error code	U1\G0
	FX5LC_1.stOutput_D.bErrorResetCommand_D	Error reset command	U1\G399, b2

■ Program to change the setting/operation mode



■ Processing program when an upper limit inputs alert occurs

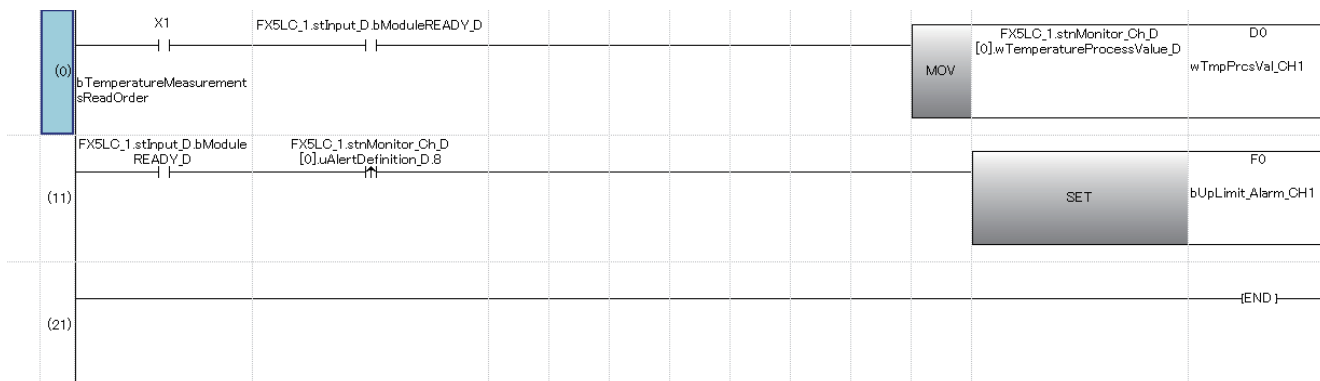

■ Program to clear the error code display

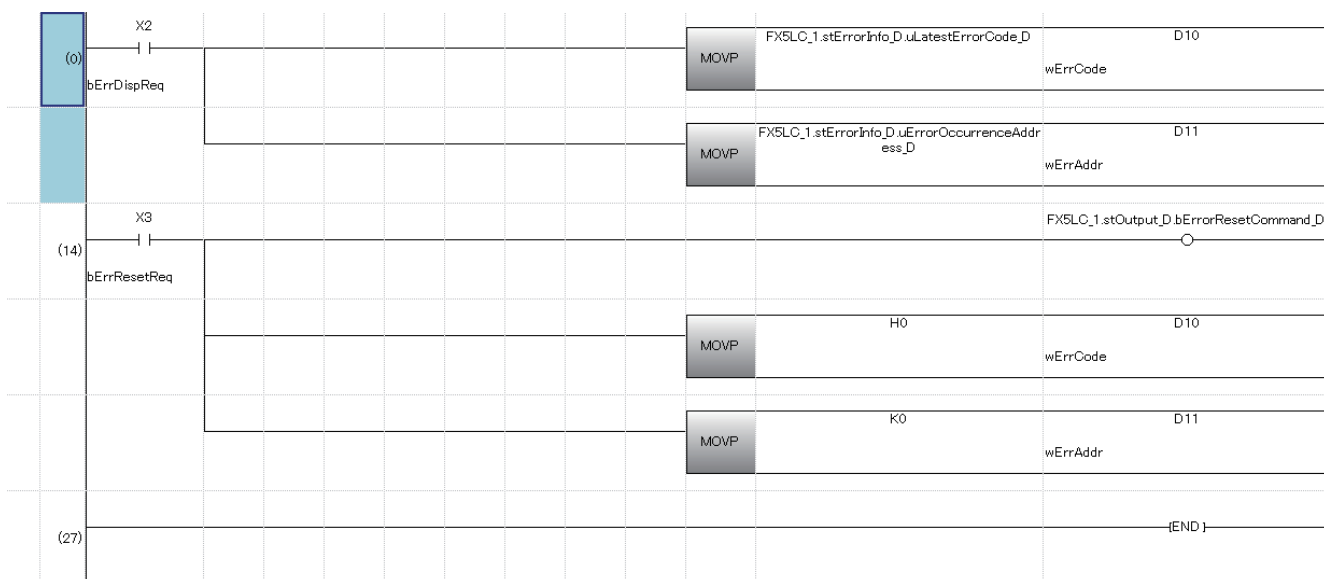

Heating-cooling PID control

System configuration

A system configuration example is described below.

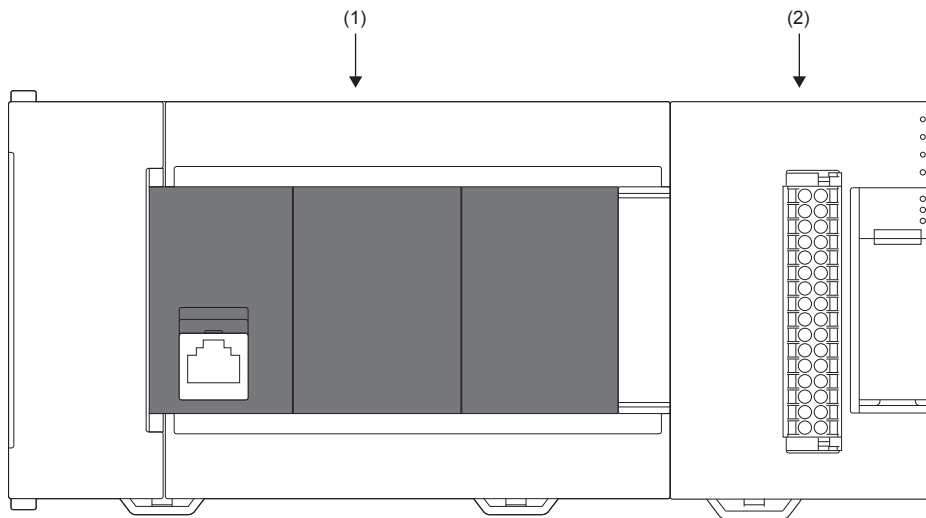

(1) CPU module (FX5U CPU module)

(2) Temperature control module (FX5-4LC)

Parameter settings

Connect GX Works3 to the CPU module to set the parameters.

Point

In the program example, default parameters are used for the parameters that have not been set. For the parameters, refer to the following.

➡ Page 77 PARAMETER SETTING

■Setting modules

For the module setting method, refer to the following.

➡ Page 82 Setting modules

■ Setting temperature control module parameters

1. Set the "Base Setting" contents as described below.

[Navigation window] ⇒ [Parameter] ⇒ [Module Information] ⇒ [FX5-4LC] ⇒ [Module Parameter] ⇒ [Base Setting]
 • "Control mode selection"

Set the "Control mode selection" as shown in the diagram below.

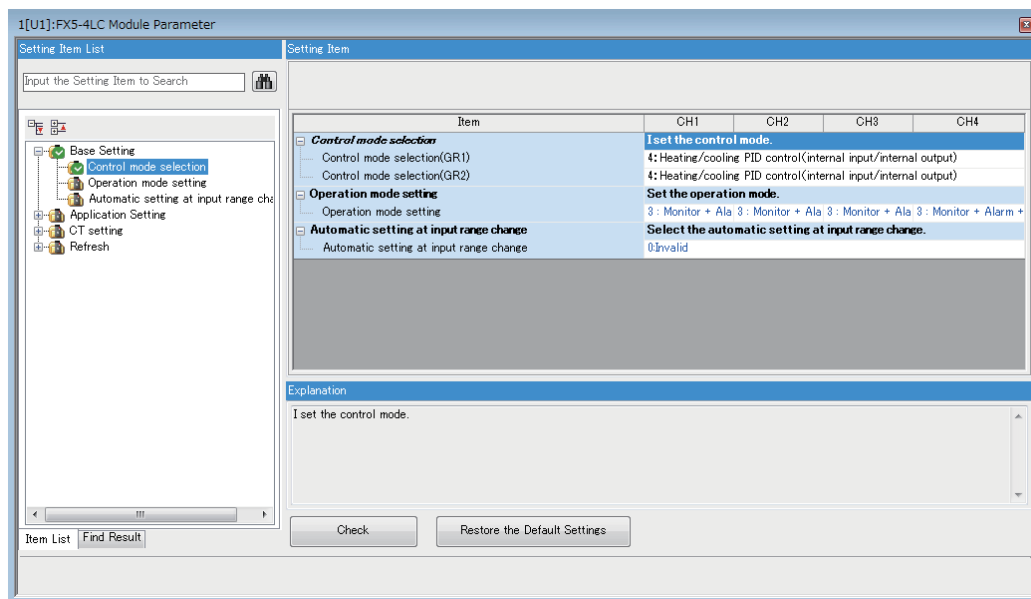

2. Set the "Application Setting" contents as described below.

[Navigation window] ⇒ [Parameter] ⇒ [Module Information] ⇒ [FX5-4LC] ⇒ [Module Parameter] ⇒ [Application Setting]
 • "Control basic parameters"

Set the CH1 "Target Value (SV) Setting" as shown in the diagram below.

Item	CH1	CH2	CH3	CH4
Control basic parameters	Set the control basic parameters.			
Input range setting	2:Thermocouple	2:Thermocouple	2:Thermocouple	2:Thermocouple K
Target Value(SV) Setting	200 °C	0 °C	0 °C	0 °C
Control output cycle setting	30.0 s	30.0 s	30.0 s	30.0 s
Control Response Parameters	0:Slow	0:Slow	0:Slow	0:Slow

• "Heating/cooling control setting"

Set the CH1 "Overlap/dead band setting" as shown in the diagram below.

Item	CH1	CH2	CH3	CH4
Heating/cooling control setting	Set this when using the heating/cooling control.			
Cooling upper limit output limiter	100.0 %	100.0 %	100.0 %	100.0 %
Cooling control output cycle setting	30.0 s	30.0 s	30.0 s	30.0 s
Cooling method setting	0:Air Cooled	0:Air Cooled	0:Air Cooled	0:Air Cooled
Overlap/dead band setting	-5.0 %	0.0 %	0.0 %	0.0 %

• "Alert setting"

Set the CH1 "Alert 1 mode setting" and "Alert set value 1" as shown in the diagram below.

Item	CH1	CH2	CH3	CH4
Alert setting	Set the temperature process value (PV) or alert status of the devi			
Alert 1 mode setting	1:Upper limit inpu	0:Not Warning	0:Not Warning	0:Not Warning
Alert 2 mode setting	0:Not Warning	0:Not Warning	0:Not Warning	0:Not Warning
Alert 3 mode setting	0:Not Warning	0:Not Warning	0:Not Warning	0:Not Warning
Alert 4 mode setting	0:Not Warning	0:Not Warning	0:Not Warning	0:Not Warning
Alert set value 1	250 °C	0 °C	0 °C	0 °C
Alert set value 2	0 °C	0 °C	0 °C	0 °C
Alert set value 3	0 °C	0 °C	0 °C	0 °C
Alert set value 4	0 °C	0 °C	0 °C	0 °C
Alert dead band setting	1.0 %	1.0 %	1.0 %	1.0 %
Number of alert delay	0 Times	0 Times	0 Times	0 Times



Use the default values for parameters not described above.

■ Writing to the CPU module

For writing to the CPU module, refer to the following.

Auto tuning

For the auto tuning procedure, refer to the following.

☞ Page 85 Auto tuning

Program example

For the program example, refer to the following.

☞ Page 86 Program example

9 TROUBLESHOOTING

This chapter describes errors that may occur when the temperature control module is used and troubleshooting.

9.1 Checks with LEDs

By checking the display status of LEDs, the problem can be primarily diagnosed without GX Works3 and the cause is narrowed down.

A state of the temperature control module can be checked with the POWER LED, RUN LED, and ERROR LED. The following table shows the correspondence between each LED status and each state of the temperature control module.

Name	Description
POWER LED	Shows the power supply status. ON: Power supply is ON OFF: Power supply is OFF or a module error has occurred
RUN LED	Shows the operations status. ON: Normal operation OFF: Error has occurred
ERROR LED	Shows the error status. ON: Mild or critical error has occurred Flashing: Moderate or critical error has occurred OFF: Normal operation

The POWER LED has turned OFF

When the POWER LED turns OFF, check the following items.

Check item	Corrective action
Is the power supplied?	Check that the supplied voltage is within the rated range.
Is the capacity insufficient?	Calculate the current consumption, and check that the power capacity is not insufficient.

The RUN LED has turned OFF

When the RUN LED turns OFF, check the following items.

Check item	Corrective action
Is the power supplied external 24 V DC? (During startup only)	Check that the external voltage supply is within the rated range.
Is the temperature control module mounted correctly? (During startup only)	Check the mounting status of the temperature control module.
Other than above	Reset the CPU module, and check that the RUN LED is ON. If the RUN LED is not ON, it is possible that the module is malfunctioning. Consult your local Mitsubishi representative, dealer, or branch office to explain the failure symptoms.

When the ERROR LED turns on or flashes

When the ERROR LED turns OFF, check the following items.

Check item	Corrective action
Has an error occurred?	Check 'Latest error code' (Un\G0), and take a corrective action described in List of Error Codes.  Page 92 List of Error Codes

9.2 Checks When Trouble Occurs

Errors detected by the temperature control module are stored in the buffer memory 'flag' (Un\G360) and 'event' (Un\G429). For the flags and events, refer to the following.

☞ Page 123 Flag

☞ Page 134 CH1 Event

Either monitor the error buffer memory using GX Works3, or read the errors using the FROM command (or specify buffer memory directly), and check the error details.

Checks using flags

The 'flag' (Un\G360) bit that describes the errors is as described below.

Bit	Error details	Error cause	Error code
b0	Error detected	Turns ON when the following b1 to b10 errors occur.	— (Other than 0)
b1	Set value range error	Turns ON when data outside the settings range is written. Further, the buffer memory number in which the error occurred is stored in the "Error occurrence address".	1950H
b2	24 V DC power supply error	Turns ON when the external 24 V DC power is not supplied.	1F08H
b3	Set value backup error flag	Turns ON when an error occurs due to noise, a malfunction occurs in the temperature control module, or the backup command turns OFF during backup. If the status does not improve even after the power supply is turned ON again, contact the closest Mitsubishi Electric representative.	1AF9H
b4	CH1 AT/ST error completion flag	Turns ON when CH1 AT (auto tuning) or ST (startup tuning) finish with an error.	1A7□H 1A8□H
b5	CH1 AT/ST error completion flag	Turns ON when CH2 AT (auto tuning) or ST (startup tuning) finish with an error.	1A9□H 1AA□H
b6	CH1 AT/ST error completion flag	Turns ON when CH3 AT (auto tuning) or ST (startup tuning) finish with an error.	1AB□H 1AC□H
b7	CH1 AT/ST error completion flag	Turns ON when CH4 AT (auto tuning) or ST (startup tuning) finish with an error.	□: CH number
b8	Adjustment data error sumcheck error	Turns ON when an error occurs due to noise or a malfunction occurs in the temperature control module. If the status does not improve even after the power supply is turned ON again, contact the closest Mitsubishi Electric representative.	3001H
b9	Cold contact temperature compensation data error		
b10	A/D converter error		

Checks using events

The 'event' (Un\G429) bit that describes the errors is as described below.

Bit	Error details	Error cause	Alarm codes/ Error codes
b0	Input error (upper limit)	Turns ON when the input value is over scale.	080□H
b1	Input error (lower limit)	Turns ON when the input value is under scale.	081□H
b2	Cold contact temperature compensation data error	Turns ON when an error occurs due to noise or a malfunction occurs in the temperature control module. If the status does not improve even after the power supply is turned ON again, contact the closest Mitsubishi Electric representative.	3001H
b3	A/D converter error		
b4	Alert 1	Turns ON when alert 1 occurs.	084□H
b5	Alert 2	Turns ON when alert 2 occurs.	085□H
b6	Alert 3	Turns ON when alert 3 occurs.	086□H
b7	Alert 4	Turns ON when alert 4 occurs.	087□H
b8	Loop disconnection alert	Turns ON when a loop disconnection alert occurs.	089□H
b9	Heater disconnection alert	Turns ON when a heater disconnection alert occurs.	088□H
b10	Current error while outputs are OFF	Turns ON when a current error occurs while outputs are OFF.	08A□H

9.3 List of Error Codes

If an error occurs in operation of the temperature control module, the error code of the error is stored into 'Latest error code' (Un\G0) of the buffer memory and 'Error flag' (Un\G398, b2) turns ON. Further, an error address is stored in 'Error occurrence address' (Un\G1).

Turning ON 'Error reset command' (Un\G399, b2) clears the error code in 'Latest error code' (Un\G0), and 'Error flag' (Un\G398, b2) turns OFF.

The following table lists the error codes to be stored.

□ in error codes: This symbol indicates the number of the channel where an error has occurred. (1: CH1, 2: CH2, 3: CH3, 4: CH4)

Error code (HEX)	Error name	Cause and description	Action
1900H	Write error in operation mode	Writing a value to the area where writing is allowed only in the setting mode was attempted in the operation mode.	Follow the instructions below to reset the error. 1: Change the mode to the setting mode. 2: Set the correct value and turn OFF→ON→OFF 'Setting change command' (Un\G399, b11). If in FX3 allocation mode, turn OFF→ON→OFF the error reset command to reset the settings range error address.
1910H	Set value discrepancy error (control mode)	The current control mode is different from the one backed up in the non-volatile memory because the control mode was changed.	Turn OFF→ON→OFF 'Setting value backup command' (Un\G399, b8).
1940H	Setting change error during default setting registration	The setting value has been changed while 'Default setting registration command' (Un\G399, b9) is ON.	After turning OFF→ON→OFF 'Error reset command' (Un\G399, b2), change the set value.
1950H	Setting out of range error	Data out of the setting range is being written.*1	Set data within the range. If in FX3 allocation mode, turn OFF→ON→OFF the error reset command to reset the settings range error address.
1A0□H	CH□ Upper/lower limit output limiter setting error	The value set in CH□ Lower limit output limiter is equal to or greater than the value set in CH□ Upper limit output limiter.	Set the value so that the upper limit value is greater than the lower limit value. If in FX3 allocation mode, turn OFF→ON→OFF the error reset command to reset the settings range error address.
1A1□H	CH□ Upper/lower limit setting limiter setting error	The value set in CH□ upper limit setting limiter and CH□ lower limit setting limiter becomes lower limit value upper limit value.	Set the value so that the upper limit value is greater than the lower limit value. If in FX3 allocation mode, turn OFF→ON→OFF the error reset command to reset the settings range error address.
1A7□H	CH□ Auto tuning error	The AT point (= Set value (SV) + AT bias) fluctuated within the upper/lower limit setting limiter range.	After turning OFF→ON→OFF 'Error reset command' (Un\G399, b2), implement the auto tuning again considering the following points. • Set the AT bias so that the temperature process value (PV) during AT does not get out of the input range. • Check the upper limit output limiter value. If the value is 100% or greater, change the value. • Change the input range to widen the measured temperature range.
1A8□H	CH□ Auto tuning error	The AT point (= Set value (SV) + AT bias) fluctuated within the upper/lower limit setting limiter range.	After turning OFF→ON→OFF 'Error reset command' (Un\G399, b2), set a set value (SV), an AT point, or an upper/lower limit setting limiter so that the set value (SV) or the AT point is within the upper/lower limit setting limiter range, and implement auto tuning again.
1A9□H	CH□ Auto tuning error	The proportional band has been set to 0.	After turning OFF→ON→OFF 'Error reset command' (Un\G399, b2), set the proportional band to a value other than 0, and implement auto tuning again.
1AA□H	CH□ Auto tuning error	Settings of the buffer memory areas where changing the settings is not allowed have been changed.	After turning OFF→ON→OFF 'Error reset command' (Un\G399, b2), implement auto tuning again. While auto tuning is being implemented, do not change the settings of the buffer memory areas.

Error code (HEX)	Error name	Cause and description	Action
1AB□H	CH□ Auto tuning error	The auto tuning error judgment time has been exceeded.*2	<p>After turning OFF→ON→OFF 'Error reset command' (Un\G399, b2), set the auto tuning error judgment time longer, and implement auto tuning again.</p> <p>■When the temperature process value (PV) does not reach the set value (SV) while the control output is ON</p> <ul style="list-style-type: none"> • Check the heater has been turned ON. • Check the upper limit output limiter value, and if the value is less than 100%, change the value. <p>■When the temperature process value (PV) does not reach the set value (SV) while the control output is OFF</p> <ul style="list-style-type: none"> • If the value is greater than 0%, change the value. • The temperatures of the controlled objects may not fall due to effects of the environment, so stop the control of the adjacent controlled objects, and implement the auto tuning for each controlled object. <p>If the error still cannot be solved after the above actions are taken, manually set the PID constants. Alternatively, change the heater capacity.</p>
1AC□H	CH□ Auto tuning error	The PID constants calculation value is out of the allowable range.	<p>After turning OFF→ON→OFF 'Error reset command' (Un\G399, b2), take the following actions depending on the situation.</p> <p>■Proportional band = 1</p> <p>Error reason: The amplitude of the control response during AT is small.</p> <ul style="list-style-type: none"> • Check the upper limit output limiter value, and if the value is less than 100%, change the value. • If the value is greater than 0%, change the value. • Change the input range to narrow the measured temperature range. <p>■Proportional band = 10000</p> <p>Error reason: The amplitude of the control response during AT is large.</p> <ul style="list-style-type: none"> • Change the upper limit output limiter value and the lower limit output limiter value to reduce the amplitude of the control response during AT. <p>■Integral time = 1</p> <p>Error reason: The vibration cycle of the control response during AT is short.</p> <ul style="list-style-type: none"> • Set the upper limit output limiter larger and the lower limit output limiter smaller. <p>■Integral time = 3600</p> <p>Error reason: The vibration cycle of the control response during AT is long.</p> <ul style="list-style-type: none"> • Check the primary delay digital filter value and change it if necessary. • Check the value for number of moving average and change it if necessary. <p>[When the temperature process value (PV) does not decrease after exceeding the set value (SV)]</p> <ul style="list-style-type: none"> • If the value is greater than 0%, change the value. • The temperatures of the controlled objects may not fall due to effects of the environment, so stop the control of the adjacent controlled objects, and implement auto tuning for each controlled object. <p>[When the temperature process value (PV) does not increase after exceeding the set value (SV)]</p> <ul style="list-style-type: none"> • Check the upper limit output limiter value, and if the value is less than 100%, change the value. <p>■Differential time = 3600</p> <p>Error reason: The vibration cycle of the control response during AT is long.</p> <ul style="list-style-type: none"> • Set the integral time to 3600 or a smaller value.

Error code (HEX)	Error name	Cause and description	Action
1AF9H	Backup errors	A read/write error to non-volatile memory occurred, or the buffer memory arrangement mode (normal mode, FX3 assignment mode) was changed.	<p>■ If the error occurs when the power supply is turned ON (i.e., when reading from non-volatile memory) Turn OFF→ON the power supply. If the same error display occurs again, turn OFF→ON→OFF 'Set value backup command' (Un\G399, b8).</p> <p>■ If the error occurs during backup using set value backup commands, or when the buffer memory arrangement mode (normal mode, FX3 assignment mode) is changed Turn OFF→ON→OFF 'Setting value backup command' (Un\G399, b8). If the same error occurs again, the possible cause is a module failure. Consult your local Mitsubishi representative, dealer, or branch office to explain the failure symptoms.</p>
1F08H	24 V DC external power supply error	24 V DC external power supply is not normally supplied to the temperature control module.	<p>Check the cable wiring and supplied voltage. After checking, turn OFF→ON→OFF 'Error reset command' (Un\G399, b2). If the same error occurs again, the possible cause is a module failure. Consult your local Mitsubishi representative, dealer, or branch office to explain the failure symptoms.</p>
3001H	Hardware failure	A hardware failure has occurred in the temperature control module.	<p>• Turn OFF→ON the power supply. If the same error occurs again, the possible cause is a temperature control module failure. Consult your local Mitsubishi representative, dealer, or branch office to explain the failure symptoms.</p>

*1 The address of buffer memory area where a value out of the setting range is set can be checked with 'Error occurrence address' (Un\G1).

*2 If "Setting change rate limiter setting" is not 0, the time monitoring starts when Set value (SV) monitor becomes equal to the AT point.

9.4 List of Alarm Codes

If an alarm occurs in operation of the temperature control module, the alarm code of the alarm is stored into 'Latest alarm code' (Un\G3) of the buffer memory. Turning OFF→ON→OFF 'Error reset command' (Un\G399, b2) clears the alarm code in 'Latest alarm code' (Un\G3).

Alarm code □: This symbol describes the number of the channel where an alarm has occurred. (1: CH1, 2: CH2, 3: CH3, 4: CH4)

Alarm code (HEX)	Alarm name	Cause and description	Action
080□H	CH□ Process value (PV) out of input range (upper limit)	The temperature process value (PV) has exceeded the temperature measuring range that was set as the input range.	After the temperature process value (PV) falls within the setting range, turn OFF→ON→OFF 'Error reset command' (Un\G399, b2) to clear the alarm code stored in 'Latest alarm code' (Un\G3).
081□H	CH□ Process value (PV) out of input range (lower limit)	The temperature process value (PV) has fallen below the temperature measuring range that was set as the input range.	After the temperature process value (PV) falls within the setting range, the corresponding bit of the warning occurrence contents and 'CH□ Alert flag' (Un\G398, b12 to 15) automatically turn OFF.
084□H	CH□ Alert 1	Alert 1 has occurred.	After the temperature process value (PV) is restored from the alert status, turn OFF→ON→OFF 'Error reset command' (Un\G3) to clear the alarm code stored in 'Latest alarm code' (Un\G3). After the temperature process value (PV) is restored from the alert status, the corresponding bit of the warning occurrence and 'CH□ Alert flag' (Un\G398, b12 to 15) automatically turn OFF.
085□H	CH□ Alert 2	Alert 2 has occurred.	
086□H	CH□ Alert 3	Alert 3 has occurred.	
087□H	CH□ Alert 4	Alert 4 has occurred.	
088□H	CH□ Heater disconnection detection	A heater disconnection has been detected.	After the detected disconnection or the detected output off-time current error is resolved, turn OFF→ON→OFF 'Error reset command' (Un\G399, b2) to clear the alarm code stored in 'Latest alarm code' (Un\G3). After the detected disconnection or the detected output OFF-time current error is resolved, the corresponding bit of the warning occurrence and 'CH□ Alert flag' (Un\G398, b12 to 15) automatically turn OFF.
089□H	CH□ Loop disconnection detection	A loop disconnection has been detected.	
08A□H	CH□ Output OFF-time current error detection	An output off-time current error has been detected.	

APPENDIX

Appendix 1 External Dimensions

This chapter describes the external dimensions of the temperature control module.

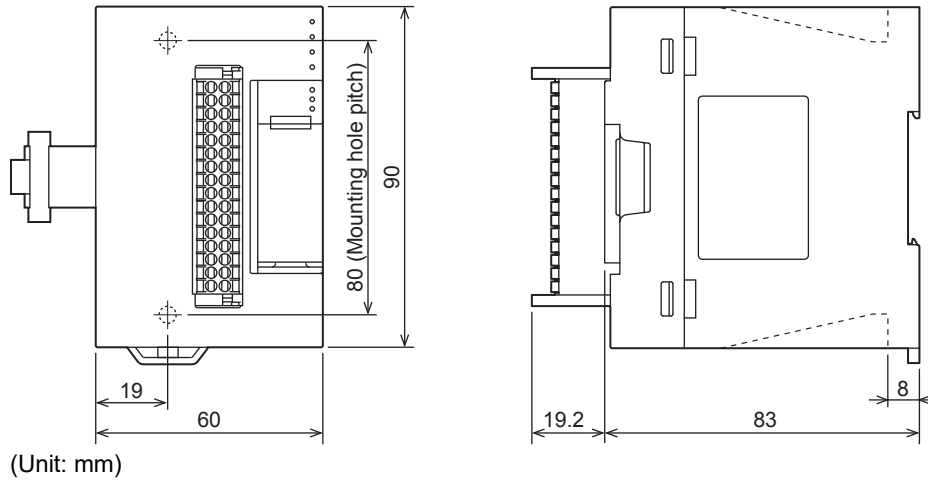

Appendix 2 Standards

Certification of UL, cUL standards

The FX5-4LC supports UL (UL, cUL) standards.

For models that support UL standards, refer to the following.

UL, cUL file number: E95239

Compliance with EC directive (CE Marking)

This note does not guarantee that an entire machine produced in accordance with the contents of this note will comply with the following standards.

Compliance to EMC directive and LVD directive of the entire mechanical module should be checked by the user/ manufacturer. For more details please contact to the local Mitsubishi Electric sales site.

Requirement for compliance with EMC directive

The following products have shown compliance through direct testing (of the identified standards below) and design analysis (through the creation of a technical construction file) to the European Directive for Electromagnetic Compatibility (2014/30/ EU) when used as directed by the appropriate documentation.

Attention

This product is designed for use in industrial applications.

Product compatibility

Type: Programmable controller (open type equipment)

Models: FX5 manufactured

Electromagnetic compatibility (EMC) directive	Remarks
from April 1st, 2017	FX5-4LC
EN61131-2:2007 Programmable controllers - Equipment requirements and tests	Compliance with all relevant aspects of the standard. EMI • Radiated emission • Conducted emission EMS • Radiated electromagnetic field • Fast transient burst • Electrostatic discharge • High-energy surge • Voltage drops and interruptions • Conducted RF • Power frequency magnetic field

If accuracy in measuring and control is required when using in an environment exposed to electrical stress, such as an EMS test, implementing the following details is recommended.

For users of proprietary cables (dedicated for sensors or actuators), these users should follow those manufacturers' installation requirements.

Mitsubishi Electric recommends that shielded cables be used. If no other EMC protection is provided, users may experience temporary loss of accuracy between +10%/-10% in very heavy industrial areas.

However, Mitsubishi Electric suggests that if adequate EMC precautions are followed with general good EMC practice for the user's complete control system, users should expect normal errors as specified in this manual.

- Sensitive analog cables should not be laid in the same trunking or cable conduit as high voltage cabling. Where possible, users should run analog cables separately.
 - Good cable shielding should be used. When terminating the shield at Earth - ensure that no earth loops are accidentally created.
 - When reading analog values, EMC induced errors can be smoothed out by averaging the readings. This can be achieved either through functions on the analog devices or through a user's program.
-

Appendix 3 Module Label

The buffer memory of the temperature control module can be set by using module labels.
Not compatible with FX3 allocation mode.

Module label configuration

The names of the module labels are defined using the following configuration.

"Module name"_"Module number"."Data type"_Ch ["(Channel)"]."Data format""Label name"_D

Ex.

FX5LC_1.stnMonitor_Ch[0].wTemperatureProcessValue_D

■Module name

The module name indicates the model of the module.

■Module number

The module number starts from one and increments for identifying modules with the same module name.

■Data type

The data type indicates the type of a buffer memory area. The following shows the classification.

Data type	Description
stnMonitor	Monitor
stnControl	Control
stnSetting	Setting

■Channel

This part indicates the channel number corresponding to a module label. A numerical value of 0 to 3 is stored to correspond to CH1 to CH4.

(CH1: 0, CH2: 1, CH3: 2, CH4: 3)

■Data type

The data type indicates the size of a buffer memory area. The following shows the classification.

Data type	Description
b	Bit
u	Word [Unsigned]/Bit String [16-bit]
w	Word [Signed]
st	Structure
z	System area
□n	Array format (□: b, u, w, st)

■Label name

The label name is unique by modules.

■_D

_D indicates that the module label is for direct access.

Type	Description	Access timing
Direct access	Values that has been read from or written to module labels are immediately applied to the module. The run time of a program is longer than the one for auto refresh. However, the responsiveness is high.	At reading/writing data from/to the module label

Appendix 4 Buffer Memory Areas

List of buffer memory addresses

The following table lists the buffer memory addresses of the temperature control module. For details on the buffer memory addresses, refer to the following.

 Page 117 Details of buffer memory addresses

The buffer memory areas of the temperature control module are classified into the following data types.

Data type	Description	
Setting data	Description	This data is set according to the connection devices and system applications.
	Write/read attribute	Data can be read and written from/to this area.
	Setting method	Set using either GX Works3 or a program.
	Setting timing	After changing values, turn OFF→ON→OFF 'Setting change command' (Un\G399, b11) to enable the set values.
Control Data	Description	Use this data to control the temperature control module.
	Write/read attribute	Data can be read and written from/to this area.
	Setting method	Set using either GX Works3 or a program.
	Setting timing	As soon as values are changed, the set values become effective.
Monitor data	Description	Use this data to monitor the status of the temperature control module.
	Write/read attribute	Reading data is only allowed.
	Setting method	—
	Setting timing	—

Point

Among the buffer memory areas, do not write data in the system areas or the areas whose data types are monitor data. Writing data into these areas can cause the malfunction of the module.

A

Using in normal mode

The following table describes the list of buffer memory addresses.

■Un\G0 to Un\G3919

Address: Decimal (hexadecimal)	CH	Setting detail		Default value	Data type	Backup	
		Standard PID control	Heating/cooling PID control				
0(0H)	All	Latest error code		0	Monitor	—	
1(1H)	All	Error occurrence address		0	Monitor	—	
2(2H)	All	Latest address of error history		0	Monitor	—	
3(3H)	All	Latest alarm code		0	Monitor	—	
4(4H)	All	Latest address of alarm history		0	Monitor	—	
5 to 30 (5H to 1EH)	—	System area		—	—	—	
31(1FH)	All	Firmware version		*1	Monitor	—	
32 to 36 (20H to 24H)	—	System area		—	—	—	
37(25H)	All	Control mode selection monitor		0	Monitor	—	
38(26H)	—	System area		—	—	—	
39(27H)	All	Automatic setting monitor at input range change		0	Monitor	—	
40 to 299 (28H to 12BH)	—	System area		—	—	—	
300 (12CH)	All	Control mode selection		0	Setting	○	
301(12DH)	—	System area		—	—	—	
302(12EH)	All	Automatic setting at input range change		0	Setting	○	
303 to 349 (12FH to 15DH)	—	System area		—	—	—	
350(15EH)	GR1	SV tracking selection	System area	1	Setting	○	
351(15FH)	GR2			1	Setting	○	
352(160H)	GR1	Cascade ON/OFF		0	Setting	—	
353(161H)	GR2			0	Setting	—	
354(162H)	GR1	Cascade gain		1000	Setting	○	
355(163H)	GR2			1000	Setting	○	
356(164H)	GR1	Cascade bias		0	Setting	○	
357(165H)	GR2			0	Setting	○	
358(166H)	GR1	Cascade monitor		0	Monitor	—	
359(167H)	GR2			0	Monitor	—	
360(168H)	All	Flag (contents of Un\G0)		0	Monitor	—	
361 to 396 (169H to 18CH)	—	System area		—	—	—	
397(18DH)	All	Module information		61C0H	Monitor	—	
398(18EH)	All	Input signal		—	Monitor	—	
399(18FH)	All	Output signal		—	Setting	—	
400(190H)	CH1	Decimal point position		0	Monitor	—	
401(191H)	CH1	Alert definition		0	Monitor	—	
402(192H)	CH1	Temperature process value (PV)		0	Monitor	—	
403(193H)	CH1	Manipulated value (MV)	Manipulated value for heating (MVh)	0	Monitor	—	
404(194H)	CH1	Temperature rise judgment flag		0	Monitor	—	
405(195H)	CH1	Transistor output flag	Heating transistor output flag	0	Monitor	—	
406(196H)	CH1	Set value (SV) monitor		0	Monitor	—	
407(197H)	CH1	Manipulated value (MV) for output with another (external) analog module	Manipulated value for heating (MVh) for output with another (external) analog module	0	Monitor	—	
408(198H)	CH1	System area	Manipulated value for cooling (MVc)	0	Monitor	—	

Address: Decimal (hexadecimal)	CH	Setting detail		Default value	Data type	Backup
		Standard PID control	Heating/cooling PID control			
409(199H)	CH1	System area	Manipulated value for cooling (MVC) for output with another (external) analog module	0	Monitor	—
410(19AH)	CH1	System area	Cooling transistor output flag	0	Monitor	—
411 to 428 (19BH to 1ACH)	—	System area		—	—	—
429(1ADH)	CH1	Event		0	Monitor	—
430(1AEH)	CH1	Set value (SV) setting		0	Control	○
431(1AFH)	CH1	Proportional band (P) setting	Heating proportional band (Ph) setting	30	Control	○
432(1B0H)	CH1	Integral time (I) setting		240	Control	○
433(1B1H)	CH1	Differential time (D) setting		60	Control	○
434(1B2H)	CH1	Alert set value 1		0	Control	○
435(1B3H)	CH1	Alert set value 2		0	Control	○
436(1B4H)	CH1	Alert set value 3		0	Control	○
437(1B5H)	CH1	Alert set value 4		0	Control	○
438(1B6H)	CH1	Temperature process value (PV) for input with another (external) analog module		0	Control	—
439(1B7H)	CH1	System area	Cooling proportional band (Pc) setting	30	Control	○
440 to 500 (1B8H to 1F4H)	—	System area		—	—	—
501(1F5H)	CH1	Input range		2	Setting	○
502, 503 (1F6H, 1F7H)	—	System area		—	—	—
504(1F8H)	CH1	Control output cycle setting	Heating control output cycle setting	300	Setting	○
505(1F9H)	CH1	Control response parameter		0	Setting	○
506(1FAH)	CH1	Temperature rise completion range setting		10	Setting	○
507(1FBH)	CH1	Temperature rise completion soak time setting		0	Setting	○
508(1FCH)	CH1	Upper limit output limiter	Heating upper limit output limiter	1000	Setting	○
509(1FDH)	CH1	Lower limit output limiter	System area	0	Setting	○
510(1FEH)	CH1	Output change ratio limiter	System area	0	Setting	○
511(1FFH)	CH1	Upper limit setting limiter		1300	Setting	○
512(200H)	CH1	Lower limit setting limiter		-100	Setting	○
513(201H)	CH1	Setting variation rate limiter		0	Setting	○
514(202H)	—	System area		—	—	—
515(203H)	CH1	Normal Operation/Reverse Operation Setting	System area	1	Setting	○
516(204H)	CH1	Adjustment sensitivity (dead band) setting		10	Setting	○
517(205H)	—	System area		—	—	—
518(206H)	CH1	AUTO/MAN mode shift	System area	0	Setting	○
519(207H)	CH1	Manual output setting	System area	-50	Setting	—
520(208H)	—	System area		—	—	—
521(209H)	CH1	System area	Cooling upper limit output limiter	1000	Setting	○
522(20AH)	CH1	System area	Cooling control output cycle setting	300	Setting	○
523(20BH)	CH1	System area	Cooling method setting	0	Setting	○
524(20CH)	CH1	System area	Overlap/dead band setting	0	Setting	○
525 to 530 (20DH to 212H)	—	System area		—	—	—
531(213H)	CH1	Alert dead band setting		10	Setting	○
532(214H)	CH1	Number of alert delay		0	Setting	○



Address: Decimal (hexadecimal)	CH	Setting detail		Default value	Data type	Backup
		Standard PID control	Heating/cooling PID control			
533(215H)	CH1	Alert 1 mode setting*2		0	Setting	○
534(216H)	CH1	Alert 2 mode setting*2		0	Setting	○
535(217H)	CH1	Alert 3 mode setting*2		0	Setting	○
536(218H)	CH1	Alert 4 mode setting*2		0	Setting	○
537(219H)	CH1	Loop disconnection detection judgment time	System area	480	Setting	○
538(21AH)	CH1	Loop disconnection detection dead band	System area	0	Setting	○
539 to 545 (21BH to 221H)	—	System area		—	—	—
546(222H)	CH1	AT bias		0	Setting	○
547(223H)	—	System area		—	—	—
548(224H)	CH1	Startup tuning implementation command	System area	0	Setting	—
549 to 562 (225H to 232H)	—	System area		—	—	—
563(233H)	CH1	Primary delay digital filter setting		0	Setting	○
564(234H)	—	System area		—	—	—
565(235H)	CH1	Sensor correction value setting		0	Setting	○
566 to 589 (236H to 24DH)	—	System area		—	—	—
590(24EH)	CH1	Operation mode setting		3	Setting	○
591(24FH)	CH1	Micro voltage input scaling upper limit		10000	Setting	○
592(250H)	CH1	Micro voltage input scaling lower limit		0	Setting	○
593(251H)	CH1	External input range upper limit		10000	Setting	○
594(252H)	CH1	External input range lower limit		0	Setting	○
595(253H)	CH1	External output range upper limit		10000	Setting	○
596(254H)	CH1	External output range lower limit		0	Setting	○
597(255H)	CH1	Transistor output functions selection		0	Setting	○
598, 599 (256H, 257H)	—	System area		—	—	—
600(258H)	CH2	Decimal point position		0	Monitor	—
601(259H)	CH2	Alert definition		0	Monitor	—
602(25AH)	CH2	Temperature process value (PV)		0	Monitor	—
603(25BH)	CH2	Manipulated value (MV)	Manipulated value for heating (MVh)	0	Monitor	—
604(25CH)	CH2	Temperature rise judgment flag		0	Monitor	—
605(25DH)	CH2	Transistor output flag	Heating transistor output flag	0	Monitor	—
606(25EH)	CH2	Set value (SV) monitor		0	Monitor	—
607(25FH)	CH2	Manipulated value (MV) for output with another (external) analog module	Manipulated value for heating (MVh) for output with another (external) analog module	0	Monitor	—
608(260H)	CH2	System area	Manipulated value for cooling (MVc)	0	Monitor	—
609(261H)	CH2	System area	Manipulated value for cooling (MVc) for output with another (external) analog module	0	Monitor	—
610(262H)	CH2	System area	Cooling transistor output flag	0	Monitor	—
611 to 629 (263H to 274H)	—	System area		—	—	—
629(275H)	CH2	Event		—	Monitor	—
630(276H)	CH2	Set value (SV) setting		0	Control	○
631(277H)	CH2	Proportional band (P) setting	Heating proportional band (Ph) setting	30	Control	○
632(278H)	CH2	Integral time (I) setting		240	Control	○

Address: Decimal (hexadecimal)	CH	Setting detail		Default value	Data type	Backup
		Standard PID control	Heating/cooling PID control			
633(279H)	CH2	Differential time (D) setting		60	Control	○
634(27AH)	CH2	Alert set value 1		0	Control	○
635(27BH)	CH2	Alert set value 2		0	Control	○
636(27CH)	CH2	Alert set value 3		0	Control	○
637(27DH)	CH2	Alert set value 4		0	Control	○
638(27EH)	CH2	Temperature process value (PV) for input with another (external) analog module		0	Control	—
639(27FH)	CH2	System area	Cooling proportional band (Pc) setting	30	Control	○
640 to 700 (280H to 2BCH)	—	System area		—	—	—
701(2BDH)	CH2	Input range		2	Setting	○
702, 703 (2BEH, 2BFH)	—	System area		—	—	—
704(2C0H)	CH2	Control output cycle setting	Heating control output cycle setting	300	Setting	○
705(2C1H)	CH2	Control response parameter		0	Setting	○
706(2C2H)	CH2	Temperature rise completion range setting		10	Setting	○
707(2C3H)	CH2	Temperature rise completion soak time setting		0	Setting	○
708(2C4H)	CH2	Upper limit output limiter	Heating upper limit output limiter	1000	Setting	○
709(2C5H)	CH2	Lower limit output limiter	System area	0	Setting	○
710(2C6H)	CH2	Output change ratio limiter	System area	0	Setting	○
711(2C7H)	CH2	Upper limit setting limiter		1300	Setting	○
712(2C8H)	CH2	Lower limit setting limiter		-100	Setting	○
713(2C9H)	CH2	Setting variation rate limiter		0	Setting	○
714(2CAH)	—	System area		—	—	—
715(2CBH)	CH2	Normal Operation/Reverse Operation Setting	System area	1	Setting	○
716(2CCH)	CH2	Adjustment sensitivity (dead band) setting		10	Setting	○
717(2CDH)	—	System area		—	—	—
718(2CEH)	CH2	AUTO/MAN mode shift	System area	0	Setting	○
719(2CFH)	CH2	Manual output setting	System area	-50	Setting	—
720(2D0H)	—	System area		—	—	—
721(2D1H)	CH2	System area	Cooling upper limit output limiter	1000	Setting	○
722(2D2H)	CH2	System area	Cooling control output cycle setting	300	Setting	○
723(2D3H)	CH2	System area	Cooling method setting	0	Setting	○
724(2D4H)	CH2	System area	Overlap/dead band setting	0	Setting	○
725 to 730 (2D5H to 2DAH)	—	System area		—	—	—
731(2DBH)	CH2	Alert dead band setting		10	Setting	○
732(2DCH)	CH2	Number of alert delay		0	Setting	○
733(2DDH)	CH2	Alert 1 mode setting ^{*2}		0	Setting	○
734(2DEH)	CH2	Alert 2 mode setting ^{*2}		0	Setting	○
735(2DFH)	CH2	Alert 3 mode setting ^{*2}		0	Setting	○
736(2E0H)	CH2	Alert 4 mode setting ^{*2}		0	Setting	○
737(2E1H)	CH2	Loop disconnection detection judgment time	System area	480	Setting	○
738(2E2H)	CH2	Loop disconnection detection dead band	System area	0	Setting	○
739 to 745 (2E3H to 2E9H)	—	System area		—	—	—

A

Address: Decimal (hexadecimal)	CH	Setting detail		Default value	Data type	Backup
		Standard PID control	Heating/cooling PID control			
746(2EAH)	CH2	AT bias		0	Setting	○
747(2EBH)	—	System area		—	—	—
748(2ECH)	CH2	Startup tuning implementation command	System area	0	Setting	—
749 to 762 (2EDH to 2FAH)	—	System area		—	—	—
763(2FBH)	CH2	Primary delay digital filter setting		0	Setting	○
764(2FCH)	—	System area		—	—	—
765(2FDH)	CH2	Sensor correction value setting		0	Setting	○
766 to 789 (2FEH to 315H)	—	System area		—	—	—
790(316H)	CH2	Operation mode setting		3	Setting	○
791(317H)	CH2	Micro voltage input scaling upper limit		10000	Setting	○
792(318H)	CH2	Micro voltage input scaling lower limit		0	Setting	○
793(319H)	CH2	External input range upper limit		10000	Setting	○
794(31AH)	CH2	External input range lower limit		0	Setting	○
795(31BH)	CH2	External output range upper limit		10000	Setting	○
796(31CH)	CH2	External output range lower limit		0	Setting	○
797(31DH)	CH2	Transistor output functions selection		0	Setting	○
798, 799 (31EH, 31FH)	—	System area		—	—	—
800(320H)	CH3	Decimal point position		0	Monitor	—
801(321H)	CH3	Alert definition		0	Monitor	—
802(322H)	CH3	Temperature process value (PV)		0	Monitor	—
803(323H)	CH3	Manipulated value (MV)	Manipulated value for heating (MVh)	0	Monitor	—
804(324H)	CH3	Temperature rise judgment flag		0	Monitor	—
805(325H)	CH3	Transistor output flag	Heating transistor output flag	0	Monitor	—
806(326H)	CH3	Set value (SV) monitor		0	Monitor	—
807(327H)	CH3	Manipulated value (MV) for output with another (external) analog module	Manipulated value for heating (MVh) for output with another (external) analog module	0	Monitor	—
808(328H)	CH3	System area	Manipulated value for cooling (MVc)	0	Monitor	—
809(329H)	CH3	System area	Manipulated value for cooling (MVc) for output with another (external) analog module	0	Monitor	—
810(32AH)	CH3	System area	Cooling transistor output flag	0	Monitor	—
811 to 828 (32BH to 33CH)	—	System area		—	—	—
829(33DH)	CH3	Event		—	Monitor	—
830(33EH)	CH3	Set value (SV) setting		0	Control	○
831(33FH)	CH3	Proportional band (P) setting		30	Control	○
832(340H)	CH3	Integral time (I) setting		240	Control	○
833(341H)	CH3	Differential time (D) setting		60	Control	○
834(342H)	CH3	Alert set value 1		0	Control	○
835(343H)	CH3	Alert set value 2		0	Control	○
836(344H)	CH3	Alert set value 3		0	Control	○
837(345H)	CH3	Alert set value 4		0	Control	○
838(346H)	CH3	Temperature process value (PV) for input with another (external) analog module		0	Control	—
839(347H)	CH3	System area	Cooling proportional band (Pc) setting	30	Control	○
840 to 900 (348H to 384H)	—	System area		—	—	—

Address: Decimal (hexadecimal)	CH	Setting detail		Default value	Data type	Backup
		Standard PID control	Heating/cooling PID control			
901(385H)	CH3	Input range		2	Setting	○
902, 903 (386H, 387H)	—	System area		—	—	—
904(388H)	CH3	Control output cycle setting	Heating control output cycle setting	300	Setting	○
905(389H)	CH3	Control response parameter		0	Setting	○
906(38AH)	CH3	Temperature rise completion range setting		10	Setting	○
907(38BH)	CH3	Temperature rise completion soak time setting		0	Setting	○
908(38CH)	CH3	Upper limit output limiter	Heating upper limit output limiter	1000	Setting	○
909(38DH)	CH3	Lower limit output limiter	System area	0	Setting	○
910(38EH)	CH3	Output change ratio limiter	System area	0	Setting	○
911(38FH)	CH3	Upper limit setting limiter		1300	Setting	○
912(390H)	CH3	Lower limit setting limiter		-100	Setting	○
913(391H)	CH3	Setting variation rate limiter		0	Setting	○
914(392H)	—	System area		—	—	—
915(393H)	CH3	Normal Operation/Reverse Operation Setting	System area	1	Setting	○
916(394H)	CH3	Adjustment sensitivity (dead band) setting		10	Setting	○
917(395H)	—	System area		—	—	—
918(396H)	CH3	AUTO/MAN mode shift	System area	0	Setting	○
919(397H)	CH3	Manual output setting	System area	-50	Setting	—
920(398H)	CH3	System area		—	—	—
921(399H)	CH3	System area	Cooling upper limit output limiter	1000	Setting	○
922(39AH)	CH3	System area	Cooling control output cycle setting	300	Setting	○
923(39BH)	CH3	System area	Cooling method setting	0	Setting	○
924(39CH)	CH3	System area	Overlap/dead band setting	0	Setting	○
925 to 930 (39DH to 3A2H)	—	System area		—	—	—
931(3A3H)	CH3	Alert dead band setting		10	Setting	○
932(3A4H)	CH3	Number of alert delay		0	Setting	○
933(3A5H)	CH3	Alert 1 mode setting ^{*2}		0	Setting	○
934(3A6H)	CH3	Alert 2 mode setting ^{*2}		0	Setting	○
935(3A7H)	CH3	Alert 3 mode setting ^{*2}		0	Setting	○
936(3A8H)	CH3	Alert 4 mode setting ^{*2}		0	Setting	○
937(3A9H)	CH3	Loop disconnection detection judgment time	System area	480	Setting	○
938(3AAH)	CH3	Loop disconnection detection dead band	System area	0	Setting	○
939 to 945 (3ABH to 3B1H)	—	System area		—	—	—
946(3B2H)	CH3	AT bias		0	Setting	○
947(3B3H)	—	System area		—	—	—
948(3B4H)	CH3	Startup tuning implementation command	System area	0	Setting	—
949 to 962 (3B5H to 3C2H)	—	System area		—	—	—
963(3C3H)	CH3	Primary delay digital filter setting		0	Setting	○
964(3C4H)	—	System area		—	—	—
965(3C5H)	CH3	Sensor correction value setting		0	Setting	○
966 to 989 (3C6H to 3DDH)	—	System area		—	—	—



Address: Decimal (hexadecimal)	CH	Setting detail		Default value	Data type	Backup
		Standard PID control	Heating/cooling PID control			
990(3DEH)	CH3	Operation mode setting		3	Setting	○
991(3DFH)	CH3	Micro voltage input scaling upper limit		10000	Setting	○
992(3E0H)	CH3	Micro voltage input scaling lower limit		0	Setting	○
993(3E1H)	CH3	External input range upper limit		10000	Setting	○
994(3E2H)	CH3	External input range lower limit		0	Setting	○
995(3E3H)	CH3	External output range upper limit		10000	Setting	○
996(3E4H)	CH3	External output range lower limit		0	Setting	○
997(3E5H)	CH3	Transistor output functions selection		0	Setting	○
998, 999 (3E6H, 3E7H)	—	System area		—	—	—
1000(3E8H)	CH4	Decimal point position		0	Monitor	—
1001(3E9H)	CH4	Alert definition		0	Monitor	—
1002(3EAH)	CH4	Temperature process value (PV)		0	Monitor	—
1003(3EBH)	CH4	Manipulated value (MV)	Manipulated value for heating (MVh)	0	Monitor	—
1004(3ECH)	CH4	Temperature rise judgment flag		0	Monitor	—
1005(3EDH)	CH4	Transistor output flag	Heating transistor output flag	0	Monitor	—
1006(3EEH)	CH4	Set value (SV) monitor		0	Monitor	—
1007(3EFH)	CH4	Manipulated value (MV) for output with another (external) analog module	Manipulated value for heating (MVh) for output with another (external) analog module	0	Monitor	—
1008(3F0H)	CH4	System area	Manipulated value for cooling (MVc)	0	Monitor	—
1009(3F1H)	CH4	System area	Manipulated value for cooling (MVc) for output with another (external) analog module	0	Monitor	—
1010(3F2H)	CH4	System area	Cooling transistor output flag	0	Monitor	—
1011 to 1029 (3F3H to 404H)	—	System area		—	—	—
1029(405H)	CH4	Event		0	Monitor	—
1030(406H)	CH4	Set value (SV) setting		0	Control	○
1031(407H)	CH4	Proportional band (P) setting		30	Control	○
1032(408H)	CH4	Integral time (I) setting		240	Control	○
1033(409H)	CH4	Differential time (D) setting		60	Control	○
1034(40AH)	CH4	Alert set value 1		0	Control	○
1035(40BH)	CH4	Alert set value 2		0	Control	○
1036(40CH)	CH4	Alert set value 3		0	Control	○
1037(40DH)	CH4	Alert set value 4		0	Control	○
1038(40EH)	CH4	Temperature process value (PV) for input with another (external) analog module		0	Control	○
1039(40FH)	CH4	System area	Cooling proportional band (Pc) setting	30	Control	○
1040 to 1100 (410H to 44CH)	—	System area		—	—	—
1101(44DH)	CH4	Input range		2	Setting	○
1102, 1103 (44EH, 44FH)	—	System area		—	—	—
1104(450H)	CH4	Control output cycle setting	Heating control output cycle setting	300	Setting	○
1105(451H)	CH4	Control response parameter		0	Setting	○
1106(452H)	CH4	Temperature rise completion range setting		10	Setting	○
1107(453H)	CH4	Temperature rise completion soak time setting		0	Setting	○
1108(454H)	CH4	Upper limit output limiter	Heating upper limit output limiter	1000	Setting	○
1109(455H)	CH4	Lower limit output limiter	System area	0	Setting	○

Address: Decimal (hexadecimal)	CH	Setting detail		Default value	Data type	Backup
		Standard PID control	Heating/cooling PID control			
1110(456H)	CH4	Output change ratio limiter	System area	0	Setting	○
1111(457H)	CH4	Upper limit setting limiter		1300	Setting	○
1112(458H)	CH4	Lower limit setting limiter		-100	Setting	○
1113(459H)	CH4	Setting variation rate limiter		0	Setting	○
1114(45AH)	—	System area		—	—	—
1115(45BH)	CH4	Normal Operation/Reverse Operation Setting	System area	1	Setting	○
1116(45CH)	CH4	Adjustment sensitivity (dead band) setting		10	Setting	○
1117(45DH)	—	System area		—	—	—
1118(45EH)	CH4	AUTO/MAN mode shift	System area	0	Setting	○
1119(45FH)	CH4	Manual output setting	System area	-50	Setting	—
1120(460H)	—	System area		—	—	—
1121(461H)	CH4	System area	Cooling upper limit output limiter	1000	Setting	○
1122(462H)	CH4	System area	Cooling control output cycle setting	300	Setting	○
1123(463H)	CH4	System area	Cooling method setting	0	Setting	○
1124(464H)	CH4	System area	Overlap/dead band setting	0	Setting	○
1125 to 1130 (465H to 46AH)	—	System area		—	—	—
1131(46BH)	CH4	Alert dead band setting		10	Setting	○
1132(46CH)	CH4	Number of alert delay		0	Setting	○
1133(46DH)	CH4	Alert 1 mode setting ^{*2}		0	Setting	○
1134(46EH)	CH4	Alert 2 mode setting ^{*2}		0	Setting	○
1135(46FH)	CH4	Alert 3 mode setting ^{*2}		0	Setting	○
1136(470H)	CH4	Alert 4 mode setting ^{*2}		0	Setting	○
1137(471H)	CH4	Loop disconnection detection judgment time	System area	480	Setting	○
1138(472H)	CH4	Loop disconnection detection dead band	System area	0	Setting	○
1139 to 1145 (473H to 479H)	—	System area		—	—	—
1146(47AH)	CH4	AT bias		0	Setting	○
1147(47BH)	—	System area		—	—	—
1148(47CH)	CH4	Startup tuning implementation command	System area	0	Setting	—
1149 to 1162 (47DH to 48AH)	—	System area		—	—	—
1163(48BH)	CH4	Primary delay digital filter setting		0	Setting	○
1164(48CH)	—	System area		—	—	—
1165(48DH)	CH4	Sensor correction value setting		0	Setting	○
1166 to 1189 (48EH to 4A5H)	—	System area		—	—	—
1190(4A6H)	CH4	Operation mode setting		3	Setting	○
1191(4A7H)	CH4	Micro voltage input scaling upper limit		10000	Setting	○
1192(4A8H)	CH4	Micro voltage input scaling lower limit		0	Setting	○
1193(4A9H)	CH4	External input range upper limit		10000	Setting	○
1194(4AAH)	CH4	External input range lower limit		0	Setting	○
1195(4ABH)	CH4	External output range upper limit		10000	Setting	○
1196(4ACH)	CH4	External output range lower limit		0	Setting	○
1197(4ADH)	CH4	Transistor output functions selection		0	Setting	○
1198 to 1999 (4AEH to 7CFH)	—	System area		—	—	—

Address: Decimal (hexadecimal)	CH	Setting detail		Default value	Data type	Backup
		Standard PID control	Heating/cooling PID control			
2000(7D0H)	All	Heater disconnection/output off-time current error detection delay count		3	Setting	○
2001(7D1H)	—	System area		—	—	—
2002(7D2H)	All	CT monitor method switching		0	Setting	○
2003(7D3H)	—	System area		—	—	—
2004(7D4H)	CH1	Heater disconnection alert setting		0	Setting	○
2005, 2006 (7D5H, 7D6H)	—	System area		—	—	—
2007(7D7H)	CH2	Heater disconnection alert setting		0	Setting	○
2008, 2009 (7D8H, 7D9H)	—	System area		—	—	—
2010(7DAH)	CH3	Heater disconnection alert setting	System area	0	Setting	○
2011, 2012 (7DBH, 7DCH)	—	System area		—	—	—
2013(7DDH)	CH4	Heater disconnection alert setting	System area	0	Setting	○
2014 to 2029 (7DFH to 7EDH)	—	System area		—	—	—
2030(7EEH)	CT1	Heater current process value		0	Monitor	—
2031(7EFH)	CT2	Heater current process value		0	Monitor	—
2032(7F0H)	CT3	Heater current process value		0	Monitor	—
2033(7F1H)	CT4	Heater current process value		0	Monitor	—
2034 to 2061 (7F2H to 80DH)	—	System area		—	—	—
2062(80EH)	CT1	CT ratio setting		800	Setting	○
2063(80FH)	CT2	CT ratio setting		800	Setting	○
2064(810H)	CT3	CT ratio setting		800	Setting	○
2065(811H)	CT4	CT ratio setting		800	Setting	○
2066 to 3599 (812H to E0FH)	—	System area		—	—	—
3600 to 3759 (E10H to EAFH)	All	Error history		0	Monitor	—
3760 to 3919 (EB0H to F4FH)	All	Alarm history		0	Monitor	—

*1 The firmware version of the FX5-4LC is stored. For Ver. 1.000, 1000 is stored.

*2 Can be changed only in the setting mode.

If using FX3 allocation mode

The following table describes the list of buffer memory addresses.

■Un\G0 to Un\G4095

Address: Decimal (hexadecimal)	CH	Setting detail		Monitor/Settings/ Selection range	Default value	Data type	Backup
		Standard PID control	Heating/cooling PID control				
0(0H)	—	Flag		☞ Page 123	—	Monitor	—
1(1H)	CH1	Event		☞ Page 134	—	Monitor	—
2(2H)	CH2						
3(3H)	CH3						
4(4H)	CH4						
5(5H)	CH1	Measurement value (PV)		input range span $\pm 5\%$	—	Monitor	—
6(6H)	CH2						
7(7H)	CH3						
8(8H)	CH4						
9(9H)	CH1	Manipulated value (control output value) (MV) monitor	Manipulated value for heating (heating control output value) (MV) monitor	-5.0 to +105.0%	—	Monitor	—
10(AH)	CH2						
11(BH)	CH3						
12(CH)	CH4						
13(DH)	CH1	System area	Manipulated value for cooling (MV) monitor	Normally 0	—	Monitor	—
14(EH)	CH2			0.0 to 105.0% -5.0 displayed when control is stopped	—	Monitor	—
15(FH)	CH3				—	Monitor	—
16(10H)	CH4			—		Monitor	—
17(11H)	CH1	Transistor output flag (Control output flag)		☞ Page 131	—	Monitor	—
18(12H)	CH2						
19(13H)	CH3						
20(14H)	CH4						
21(15H)	CH1	Heater current process value		0.0 to 105.0 A	—	Monitor	—
22(16H)	CH2						
23(17H)	CH3						
24(18H)	CH4						
25(19H)	CH1	Temperature process value for input with another (external) analog module		-32768 to +32767	0	Control	—
26(1AH)	CH2						
27(1BH)	CH3						
28(1CH)	CH4						
29(1DH)	All	Control start/stop switching		0: Control stop 1: Control start	0	Control	—
30(1EH)	All	Module information		61C2H	61C2H	Monitor	—
31(1FH)	All	Firmware version		*1	*1	Monitor	—
32(20H)	CH1	Manipulated value (MV) for output with another (external) analog module monitor	Manipulated value (MVh) for heating for output with another (external) analog module monitor	External output range lower limit to upper limit	0	Monitor	—
33(21H)	CH2						
34(22H)	CH3						
35(23H)	CH4						
36(24H)	CH1	System area	Manipulated value (MVc) for cooling for output with another (external) analog module monitor		0	Monitor	—
37(25H)	CH2						
38(26H)	CH3						
39(27H)	CH4						
40(28H)	CH1	Set value (SV) monitor		Lower limit setting limiter to upper limit setting limiter	0	Monitor	—
41(29H)	CH2						
42(2AH)	CH3						
43(2BH)	CH4						

Address: Decimal (hexadecimal)	CH	Setting detail		Monitor/Settings/ Selection range	Default value	Data type	Backup
		Standard PID control	Heating/cooling PID control				
44(2CH)	CH1	Control mode monitor		b0 to 2: Control mode b15: Cascade control implementation status	0	Monitor	—
45(2DH)	CH2						
46(2EH)	CH3						
47(2FH)	CH4						
48(30H)	CH1	Set value (SV) setting		Within setting limiter range	0	Control	○
49(31H)	CH1	Alert 1 set value		Depends on alert mode and input type	0	Control	○
50(32H)	CH1	Alert 2 set value		Depends on alert mode and input type	0	Control	○
51(33H)	CH1	Alert 3 set value		Depends on alert mode and input type	0	Control	○
52(34H)	CH1	Alert 4 set value		Depends on alert mode and input type	0	Control	○
53(35H)	CH1	Heater disconnection alert setting		0 to 1000 (0.0 to 100.0 A) (0: Heater disconnection detection function OFF)	0	Control	○
54(36H)	CH1	AUTO/MAN mode switching	System area	0: AUTO 1: MAN	0	Setting	○
55(37H)	CH1	Manual output settings	System area	-50 to +1050	-50/0	Setting	—
56(38H)	CH1	AT (auto tuning) implementation command		0: Stop AT 1: Implement AT	0	Normal	○
57(39H)	CH1	Operation mode setting		0: Not used 1: Monitor only 2: Monitor + alert 3: Monitor + alert + control	3	Setting	○
58(3AH)	CH1	Proportional band (P) setting	Heating proportional band (P) setting	0 to 10000 (0.1 to 1000.0% span) Set 0 to use position 2 controls.	30	Control	○
59(3BH)	CH1	System area	Cooling proportional band setting	1 to 10000 (0.1 to 1000.0% span)	30	Control	○
60(3CH)	CH1	Integral time (I) setting		0 to 3600s	240	Control	○
61(3DH)	CH1	Differential time (D) setting		0 to 3600s	60	Control	○
62(3EH)	CH1	Control response parameter		0: Slow 1: Regular 2: Fast	0	Setting	○
63(3FH)	CH1	System area	Overlap/dead band	-100 to +100	0	Setting	○
64(40H)	CH1	Upper limit output limiter	Heating upper limit output limiter	Lower limit output limiter +1 to 1050/0 to 1050	1000	Setting	○
65(41H)	CH1	Lower limit output limiter	System area	-50 to upper limit output limiter -1	0	Setting	○
66(42H)	CH1	System area	Cooling upper limit output limiter	—	0	Setting	○
67(43H)	CH1	Output change ratio limiter	System area	0 to 1000	0	Setting	○
68(44H)	CH1	Sensor correction value setting		-5000 to +5000	0	Setting	○
69(45H)	CH1	Controller sensitivity (dead band) setting		0 to 100	10	Setting	○
70(46H)	CH1	Control output cycle setting	Heating control output cycle setting	5 to 1000 (0.5 to 100.0s)	300	Setting	○
71(47H)	CH1	System area	Cooling control output cycle setting	5 to 1000 (0.5 to 100.0s)	0/300	Setting	○
72(48H)	CH1	Primary delay digital filter setting		0 to 100s (0: Function OFF)	0	Setting	○
73(49H)	CH1	Setting variation rate limiter		0 to 1000	0	Setting	○
74(4AH)	CH1	AT bias		±Input span [°C, °F, digit]	0	Setting	○
75(4BH)	CH1	Normal Operation/ Reverse Operation Setting	System area	0: Normal Operation 1: Reverse Operation	1/0	Setting	○

Address: Decimal (hexadecimal)	CH	Setting detail		Monitor/Settings/ Selection range	Default value	Data type	Backup
		Standard PID control	Heating/cooling PID control				
76(4CH)	CH1	Upper limit setting limiter		Lower limit setting limiter value +1 to input range upper limit	1300	Setting	○
77(4DH)	CH1	Lower limit setting limiter		Input range lower limit to Upper limit setting limiter value -1	-100	Setting	○
78(4EH)	CH1	Loop disconnection detection judgment time	System area	0 to 7200 s	480/0	Setting	○
79(4FH)	CH1	Loop disconnection detection dead band	System area	0.0 or 0 to input span	0	Setting	○
80(50H)	CH1	Micro voltage input scaling upper limit		-20000 to +20000	10000	Setting	○
81(51H)	CH1	Micro voltage input scaling lower limit		(Upper and lower limit reverse operation disabled, 20000 max. using span)	0	Setting	○
82(52H)	CH1	External input range upper limit		-32000 to +32000	10000	Setting	○
83(53H)	CH1	External input range lower limit		(Upper and lower limit reverse operation disabled)	0	Setting	○
84(54H)	CH1	External output range upper limit		-32000 to +32000	10000	Setting	○
85(55H)	CH1	External output range lower limit		(Upper and lower limit reverse operation disabled)	0	Setting	○
86(56H)	CH1	Transistor output functions selection		☞ Page 161	0	Setting	○
87(57H)	CH1	Startup tuning implementation command		0: Disabled 1: Enabled	0	Setting	—
88(58H)	CH2	Set value (SV) setting		Within setting limiter range	0	Control	○
89(59H)	CH2	Alert 1 set value		Depends on alert mode and input type	0	Control	○
90(5AH)	CH2	Alert 2 set value		Depends on alert mode and input type	0	Control	○
91(5BH)	CH2	Alert 3 set value		Depends on alert mode and input type	0	Control	○
92(5CH)	CH2	Alert 4 set value		Depends on alert mode and input type	0	Control	○
93(5DH)	CH2	Heater disconnection alert setting		0 to 1000 (0.0 to 100.0 A) (0: Heater disconnection detection function OFF)	0	Control	○
94(5EH)	CH2	AUTO/MAN mode switching	System area	0: AUTO 1: MAN	0	Setting	○
95(5FH)	CH2	Manual output settings	System area	-50 to +1050	-50/0	Setting	—
96(60H)	CH2	AT (auto tuning) implementation command		0: Stop AT 1: Implement AT	0	Normal	○
97(61H)	CH2	Operation mode setting		0: Not used 1: Monitor only 2: Monitor + alert 3: Monitor + alert + control	3	Setting	○
98(62H)	CH2	Proportional band (P) setting	Heating proportional band (P) setting	0 to 10000 (0.1 to 1000.0% span) Set 0 to use position 2 controls.	30	Control	○
99(63H)	CH2	System area	Cooling proportional band setting	1 to 10000 (0.1 to 1000.0% span)	30	Control	○
100(64H)	CH2	Integral time (I) setting		0 to 3600 s	240	Control	○
101(65H)	CH2	Differential time (D) setting		0 to 3600 s	60	Control	○
102(66H)	CH2	Control response parameter		0: Slow 1: Regular 2: Fast	0	Setting	○
103(67H)	CH2	System area	Overlap/dead band	-100 to +100	0	Setting	○
104(68H)	CH2	Upper limit output limiter	Heating upper limit output limiter	Lower limit output limiter +1 to 1050/0 to 1050	1000	Setting	○

Address: Decimal (hexadecimal)	CH	Setting detail		Monitor/Settings/ Selection range	Default value	Data type	Backup
		Standard PID control	Heating/cooling PID control				
105(69H)	CH2	Lower limit output limiter	System area	-50 to upper limit output limiter -1	0	Setting	○
106(6AH)	CH2	System area	Cooling upper limit output limiter	—	0	Setting	○
107(6BH)	CH2	Output change ratio limiter	System area	0 to 1000	0	Setting	○
108(6CH)	CH2	Sensor correction value setting		-5000 to +5000	0	Setting	○
109(6DH)	CH2	Controller sensitivity (dead band) setting		0 to 100	10	Setting	○
110(6EH)	CH2	Control output cycle setting	Heating control output cycle setting	5 to 1000 (0.5 to 100.0 s)	300	Setting	○
111(6FH)	CH2	System area	Cooling control output cycle setting	5 to 1000 (0.5 to 100.0 s)	0/300	Setting	○
112(70H)	CH2	Primary delay digital filter setting		0 to 100 s (0: Function OFF)	0	Setting	○
113(71H)	CH2	Setting variation rate limiter		0 to 1000	0	Setting	○
114(72H)	CH2	AT bias		±Input span [°C, °F, digit]	0	Setting	○
115(73H)	CH2	Normal Operation/ Reverse Operation Setting	System area	0: Normal Operation 1: Reverse Operation	1/0	Setting	○
116(74H)	CH2	Upper limit setting limiter		Lower limit setting limiter value +1 to input range upper limit	1300	Setting	○
117(75H)	CH2	Lower limit setting limiter		Input range lower limit to Upper limit setting limiter value -1	-100	Setting	○
118(76H)	CH2	Loop disconnection detection judgment time	System area	0 to 7200 s	480/0	Setting	○
119(77H)	CH2	Loop disconnection detection dead band	System area	0.0 or 0 to input span	0	Setting	○
120(78H)	CH2	Micro voltage input scaling upper limit		-20000 to +20000	10000	Setting	○
121(79H)	CH2	Micro voltage input scaling lower limit		(Upper and lower limit reverse operation disabled, 20000 max. using span)	0	Setting	○
122(7AH)	CH2	External input range upper limit		-32000 to +32000	10000	Setting	○
123(7BH)	CH2	External input range lower limit		(Upper and lower limit reverse operation disabled)	0	Setting	○
124(7CH)	CH2	External output range upper limit		-32000 to +32000	10000	Setting	○
125(7DH)	CH2	External output range lower limit		(Upper and lower limit reverse operation disabled)	0	Setting	○
126(7EH)	CH2	Transistor output functions selection		☞ Page 161	0	Setting	○
127(7FH)	CH2	Startup tuning implementation command		0: Disabled 1: Enabled	0	Setting	—
128(80H)	CH3	Set value (SV) setting		Within setting limiter range	0	Control	○
129(81H)	CH3	Alert 1 set value		Depends on alert mode and input type	0	Control	○
130(82H)	CH3	Alert 2 set value		Depends on alert mode and input type	0	Control	○
131(83H)	CH3	Alert 3 set value		Depends on alert mode and input type	0	Control	○
132(84H)	CH3	Alert 4 set value		Depends on alert mode and input type	0	Control	○
133(85H)	CH3	Heater disconnection alert setting		0 to 1000 (0.0 to 100.0 A) (0: Heater disconnection detection function OFF)	0	Control	○
134(86H)	CH3	AUTO/MAN mode switching	System area	0: AUTO 1: MAN	0	Setting	○
135(87H)	CH3	Manual output settings		System area	-50 to +1050	Setting	—

Address: Decimal (hexadecimal)	CH	Setting detail		Monitor/Settings/ Selection range	Default value	Data type	Backup
		Standard PID control	Heating/cooling PID control				
136(88H)	CH3	AT (auto tuning) implementation command		0: Stop AT 1: Implement AT	0	Normal	○
137(89H)	CH3	Operation mode setting		0: Not used 1: Monitor only 2: Monitor + alert 3: Monitor + alert + control	3	Setting	○
138(8AH)	CH3	Proportional band (P) setting	Heating proportional band (P) setting	0 to 10000 (0.1 to 1000.0% span) Set 0 to use position 2 controls.	30	Control	○
139(8BH)	CH3	System area	Cooling proportional band setting	1 to 10000 (0.1 to 1000.0% span)	30	Control	○
140(8CH)	CH3	Differential time (I) setting		0 to 3600 s	240	Control	○
141(8DH)	CH3	Differential time (D) setting		0 to 3600 s	60	Control	○
142(8EH)	CH3	Control response parameter		0: Slow 1: Regular 2: Fast	0	Setting	○
143(8FH)	CH3	System area	Overlap/dead band	-100 to +100	0	Setting	○
144(90H)	CH3	Upper limit output limiter	Heating upper limit output limiter	Lower limit output limiter +1 to 1050/0 to 1050	1000	Setting	○
145(91H)	CH3	Lower limit output limiter	System area	-50 to upper limit output limiter -1	0	Setting	○
146(92H)	CH3	System area	Cooling upper limit output limiter	—	0	Setting	○
147(93H)	CH3	Output change ratio limiter	System area	0 to 1000	0	Setting	○
148(94H)	CH3	Sensor correction value setting		-5000 to +5000	0	Setting	○
149(95H)	CH3	Controller sensitivity (dead band) setting		0 to 100	10	Setting	○
150(96H)	CH3	Control output cycle setting	Heating control output cycle setting	5 to 1000 (0.5 to 100.0s)	300	Setting	○
151(97H)	CH3	System area	Cooling control output cycle setting	5 to 1000 (0.5 to 100.0s)	0/300	Setting	○
152(98H)	CH3	Primary delay digital filter setting		0 to 100 s (0: Function OFF)	0	Setting	○
153(99H)	CH3	Setting variation rate limiter		0 to 1000	0	Setting	○
154(9AH)	CH3	AT bias		±Input span [°C, °F, digit]	0	Setting	○
155(9BH)	CH3	Normal Operation/ Reverse Operation Setting	System area	0: Normal Operation 1: Reverse Operation	1/0	Setting	○
156(9CH)	CH3	Upper limit setting limiter		Lower limit setting limiter value +1 to input range upper limit	1300	Setting	○
157(9DH)	CH3	Lower limit setting limiter		Input range lower limit to Upper limit setting limiter value -1	-100	Setting	○
158(9EH)	CH3	Loop disconnection detection judgment time constant	System area	0 to 7200 s	480/0	Setting	○
159(9FH)	CH3	Loop disconnection detection dead band	System area	0.0 or 0 to input span	0	Setting	○
160(A0H)	CH3	Micro voltage input scaling upper limit		-20000 to +20000	10000	Setting	○
161(A1H)	CH3	Micro voltage input scaling lower limit		(Upper and lower limit reverse operation disabled, 20000 max. using span)	0	Setting	○
162(A2H)	CH3	External input range upper limit		-32000 to +32000	10000	Setting	○
163(A3H)	CH3	External input range lower limit		(Upper and lower limit reverse operation disabled)	0	Setting	○
164(A4H)	CH3	External output range upper limit		-32000 to +32000	10000	Setting	○

Address: Decimal (hexadecimal)	CH	Setting detail		Monitor/Settings/ Selection range	Default value	Data type	Backup
		Standard PID control	Heating/cooling PID control				
165(A5H)	CH3	External output range lower limit		(Upper and lower limit reverse operation disabled)	0	Setting	○
166(A6H)	CH3	Transistor output functions selection		☞ Page 161	0	Setting	○
167(A7H)	CH3	Startup tuning implementation command		0: Disabled 1: Enabled	0	Setting	—
168(A8H)	CH4	Set value (SV) setting		Within setting limiter range	0	Control	○
169(A9H)	CH4	Alert 1 set value		Depends on alert mode and input type	0	Control	○
170(AAH)	CH4	Alert 2 set value		Depends on alert mode and input type	0	Control	○
171(ABH)	CH4	Alert 3 set value		Depends on alert mode and input type	0	Control	○
172(ACH)	CH4	Alert 4 set value		Depends on alert mode and input type	0	Control	○
173(ADH)	CH4	Heater disconnection alert setting		0 to 1000 (0.0 to 100.0 A) (0: Heater disconnection detection function OFF)	0	Control	○
174(AEH)	CH4	AUTO/MAN mode switching	System area	0: AUTO 1: MAN	0	Setting	○
175(AFH)	CH4	Manual output settings	System area	-50 to +1050	-50/0	Setting	—
176(B0H)	CH4	AT (auto tuning) implementation command		0: Stop AT 1: Implement AT	0	Normal	○
177(B1H)	CH4	Operation mode setting		0: Not used 1: Monitor only 2: Monitor + alert 3: Monitor + alert + control	3	Setting	○
178(B2H)	CH4	Proportional band (P) setting	Heating proportional band (P) setting	0 to 10000 (0.1 to 1000.0% span) Set 0 to use position 2 controls.	30	Control	○
179(B3H)	CH4	System area	Cooling proportional band setting	1 to 10000 (0.1 to 1000.0% span)	30	Control	○
180(B4H)	CH4	Integral time (I) setting		0 to 3600 s	240	Control	○
181(B5H)	CH4	Differential time (D) setting		0 to 3600 s	60	Control	○
182(B6H)	CH4	Control response parameter		0: Slow 1: Regular 2: Fast	0	Setting	○
183(B7H)	CH4	System area	Overlap/dead band	-100 to +100	0	Setting	○
184(B8H)	CH4	Upper limit output limiter	Heating upper limit output limiter	Lower limit output limiter +1 to 1050/0 to 1050	1000	Setting	○
185(B9H)	CH4	Lower limit output limiter	System area	-50 to upper limit output limiter -1	0	Setting	○
186(BAH)	CH4	System area	Cooling upper limit output limiter	—	0	Setting	○
187(BBH)	CH4	Output change ratio limiter	System area	0 to 1000	0	Setting	○
188(BBH)	CH4	Sensor correction value setting		-5000 to +5000	0	Setting	○
189(BCH)	CH4	Controller sensitivity (dead band) setting		0 to 100	10	Setting	○
190(BEH)	CH4	Control output cycle setting	Heating control output cycle setting	5 to 1000 (0.5 to 100.0s)	300	Setting	○
191(BFH)	CH4	System area	Cooling control output cycle setting	5 to 1000 (0.5 to 100.0s)	0/300	Setting	○
192(C0H)	CH4	Primary delay digital filter setting		0 to 100 s (0: Function OFF)	0	Setting	○
193(C1H)	CH4	Setting variation rate limiter		0 to 1000	0	Setting	○
194(C2H)	CH4	AT bias		±Input span [°C, °F, digit]	0	Setting	○
195(C3H)	CH4	Normal Operation/ Reverse Operation Setting	System area	0: Normal Operation 1: Reverse Operation	1/0	Setting	○

Address: Decimal (hexadecimal)	CH	Setting detail		Monitor/Settings/ Selection range	Default value	Data type	Backup
		Standard PID control	Heating/cooling PID control				
196(C4H)	CH4	Upper limit setting limiter		Lower limit setting limiter value +1 to input range upper limit	1300	Setting	○
197(C5H)	CH4	Lower limit setting limiter		Input range lower limit to Upper limit setting limiter value -1	-100	Setting	○
198(C6H)	CH4	Loop disconnection detection judgment time	System area	0 to 7200 s	480/0	Setting	○
199(C7H)	CH4	Loop disconnection detection dead band	System area	0.0 or 0 to input span	0	Setting	○
200(C8H)	CH4	Micro voltage input scaling upper limit		-20000 to +20000	10000	Setting	○
201(C9H)	CH4	Micro voltage input scaling lower limit		(Upper and lower limit reverse operation disabled, 20000 max. using span)	0	Setting	○
202(CAH)	CH4	External input range upper limit		-32000 to +32000	10000	Setting	○
203(CBH)	CH4	External input range lower limit		(Upper and lower limit reverse operation disabled)	0	Setting	○
204(CCH)	CH4	External output range upper limit		-32000 to +32000	10000	Setting	○
205(CDH)	CH4	External output range lower limit		(Upper and lower limit reverse operation disabled)	0	Setting	○
206(CEH)	CH4	Transistor output functions selection		☞ Page 161	0	Setting	○
207(CFH)	CH4	Startup tuning implementation command		0: Disabled 1: Enabled	0	Setting	—
208(D0H)	CH1	Input range		☞ Page 140	2	Setting	○
209(D1H)	CH1	Alert 1 mode setting		0 to 14	0	Setting	○
210(D2H)	CH1	Alert 2 mode setting		0 to 14	0	Setting	○
211(D3H)	CH1	Alert 3 mode setting		0 to 14	0	Setting	○
212(D4H)	CH1	Alert 4 mode setting		0 to 14	0	Setting	○
213(D5H)	CH1	System area		—	0	—	—
214(D6H)	CH2	Input range		☞ Page 140	2	Setting	○
215(D7H)	CH2	Alert 1 mode setting		0 to 14	0	Setting	○
216(D8H)	CH2	Alert 2 mode setting		0 to 14	0	Setting	○
217(D9H)	CH2	Alert 3 mode setting		0 to 14	0	Setting	○
218(DAH)	CH2	Alert 4 mode setting		0 to 14	0	Setting	○
219(DBH)	CH2	System area		—	0	—	—
220(DCH)	CH3	Input range		☞ Page 140	2	Setting	○
221(DDH)	CH3	Alert 1 mode setting		0 to 14	0	Setting	○
222(DEH)	CH3	Alert 2 mode setting		0 to 14	0	Setting	○
223(DFH)	CH3	Alert 3 mode setting		0 to 14	0	Setting	○
224(E0H)	CH3	Alert 4 mode setting		0 to 14	0	Setting	○
225(E1H)	CH3	System area		—	0	—	—
226(E2H)	CH4	Input range		☞ Page 140	2	Setting	○
227(E3H)	CH4	Alert 1 mode setting		0 to 14	0	Setting	○
228(E4H)	CH4	Alert 2 mode setting		0 to 14	0	Setting	○
229(E5H)	CH4	Alert 3 mode setting		0 to 14	0	Setting	○
230(E6H)	CH4	Alert 4 mode setting		0 to 14	0	Setting	○
231(E7H)	CH4	System area		—	—	—	—
232(E8H)	—	System area	Cooling method setting	0: Air cooling 1: Water cooling 2: Cooling gain linear	0	Setting	○
233(E9H)	—	Alert dead band setting		0 to 100	10	Setting	○
234(EAH)	—	Number of alert delay		0 to 30000 times	0	Setting	○
235(EBH)	—	Heater disconnection alert/Abnormal current detection delay count setting during outputs OFF		3 to 255 times	3	Setting	○

Address: Decimal (hexadecimal)	CH	Setting detail		Monitor/Settings/ Selection range	Default value	Data type	Backup
		Standard PID control	Heating/cooling PID control				
236(ECH)	—	Temperature rise completion judgment range		1 to 100 [°C, °F, digit]	10	Setting	○
237(EDH)	—	Temperature rise completion soak time setting		0 to 3600 s	0	Setting	○
238(EEH)	—	CT monitor method switching		0: ON current/OFF current 1: ON current	0	Setting	○
239(EFH)	—	CT ratio setting		1 to 9999	800	Setting	○
240(F0H)	GR1	Control mode switching		0 to 3: Standard PID 4 to 7: Heating/cooling PID	0	Setting	○
241(F1H)	GR2	Control mode switching					
242(F2H)	GR1	Standard control	SV tracking selection	0: OFF 1: ON	1	Setting	○
243(F3H)	GR2	Heating-cooling control	System area	—	0		
244(F4H)	GR1	Standard control	Cascade ON/OFF	0: Cascade OFF 1: Cascade ON	0	Setting	—
245(F5H)	GR2	Heating-cooling control	System area	—	0		
246(F6H)	GR1	Standard control	Cascade gain	-10000 to +10000	1000	Setting	○
247(F7H)	GR2	Heating-cooling control	System area	—	0		
248(F8H)	GR1	Standard control	Cascade bias	-1000 to +1000	0	Setting	○
249(F9H)	GR2	Heating-cooling control	System area	—	0		
250(FAH)	GR1	Standard control	Cascade monitor	-32000 to +32000	0	Monitor	—
251(FBH)	GR2	Heating-cooling control	System area	—	0		
252(FCH)	—	Settings range error address		0: Normal 1 or greater: Error address	0	Monitor	—
253(FDH)	—	Error reset command		0: Error reset OFF 1: Implement error reset	0	Setting	—
254(FEH)	—	Set value backup command		0: Normal 1: Start backup	0	Setting	—
255(FFH)	—	Default setting registration command		0: OFF 1: All data default 2: Un\G48 to 207, 232, 242 to 255 default	0	Setting	—
256 to 999 (100H to 3E7H)	—	System area		—	—	—	—
1000(3E8H)	—	Latest error code		—	0	Monitor	—
1001(3E9H)	—	Error occurrence address		—	0	Monitor	—
1002(3EAH)	—	Latest address of error history		—	0	Monitor	—
1003(3EBH)	—	Latest alarm code		—	0	Monitor	—
1004(3ECH)	—	Latest address of alarm history		—	0	Monitor	—
1005 to 3599 (3EDH to E0FH)	—	System area		—	—	—	—
3600 to 3759 (E10H to EAFH)	All	Error history		—	0	Monitor	—
3760 to 3919 (EB0H to F4FH)	All	Alarm history		—	0	Monitor	—
3920 to 4095 (F50H to FFFH)	—	System area		—	—	—	—

*1 The firmware version of the FX5-4LC is stored. For Ver. 1.000, 1000 is stored.

Details of buffer memory addresses

This section describes the details of buffer memory addresses of the temperature control module.



This section describes the buffer memory for CH1 in normal mode.

Latest error code

The latest error code detected by the temperature control module is stored. For error codes, refer to the following.

Page 92 List of Error Codes

■Buffer memory address

The following table shows the buffer memory address of this area.

Buffer memory name	CH1	CH2	CH3	CH4
Latest error code	0			
Latest error code (If using FX3 allocation mode)	1000			

Error occurrence address (Settings range error address)

The address where an error has occurred is stored.

■Buffer memory address

The following table shows the buffer memory address of this area.

Buffer memory name	CH1	CH2	CH3	CH4
Error occurrence address	1			
Error occurrence address (If using FX3 allocation mode)	252*1, 1001			

*1 Un\G252 when using FX3 allocation mode stores only the settings range errors.

Latest address of error history

Among 'Error history' (Un\G3600 to Un\G3759), the buffer memory address where the latest error code has been stored is stored.

■Buffer memory address

The following table shows the buffer memory address of this area.

Buffer memory name	CH1	CH2	CH3	CH4
Latest address of error history	2			
Latest address of error history (If using FX3 allocation mode)	1002			

Latest alarm code

The latest alarm code detected by the temperature control module is stored. For alarm codes, refer to the following.

Page 94 List of Alarm Codes

■Buffer memory address

The following table shows the buffer memory address of this area.

Buffer memory name	CH1	CH2	CH3	CH4
Latest alarm code	3			
Latest alarm code (If using FX3 allocation mode)	1003			



Latest address of alarm history

Among "Alarm history" (Un\G3760 to Un\G3919), the buffer memory address where the latest alarm code has been stored is stored.

■Buffer memory address

The following table shows the buffer memory address of this area.

Buffer memory name	CH1	CH2	CH3	CH4
Latest address of alarm history	4			
Latest address of alarm history (If using FX3 allocation mode)	1004			

Firmware version

The temperature control module firmware version is stored.

■Buffer memory address

The following table shows the buffer memory address of this area.

Buffer memory name	CH1	CH2	CH3	CH4
Firmware version	31			
Firmware version (when using FX3 allocation mode)	31			

Control mode selection monitor

Control mode selection or the cascade ON/OFF settings details are stored. The following table lists stored values and the details.

Normal mode	FX3 allocation mode
(1) "Control mode selection" (Un\G300) is stored in bits 1 to 3 for each channel. (2) "Cascade ON/OFF" (Un\G352) is stored in bit 4 for each channel.	(1) "Control mode selection" (Un\G240) is stored in bits 1 to 3. (2) "Cascade ON/OFF" (Un\G244) is stored in bit 16 for each channel.
<p>Bit 15 14 13 12 11 10 9 8 7 6 5 4 3 2 1 0</p> <p>(2) (1) (2) (1) (2) (1) (2) (1) (2) (1)</p>	<p>Bit 15 14 13 12 11 10 9 8 7 6 5 4 3 2 1 0</p> <p>(2) (1)</p>

(1) Control mode selection	Control mode	Control types	Input	Output
000	0	Standard PID control	Internal	Internal
001	1	Standard PID control	External	Internal
010	2	Standard PID control	Internal	External
011	3	Standard PID control	External	External
100	4	Heating/cooling PID control	Internal	Internal
101	5	Heating/cooling PID control	External	Internal
110	6	Heating/cooling PID control	Internal	External
111	7	Heating/cooling PID control	External	External

(2) Cascade ON/OFF	Description
0	Cascade control OFF
1	Cascade control ON

■Buffer memory address

The following table shows the buffer memory address of this area.

Buffer memory name	CH1	CH2	CH3	CH4
Control mode selection monitor	37			
Control mode selection monitor (If using FX3 allocation mode)	44	45	46	47

Automatic setting monitor at input range change

The value set in 'Automatic setting at input range change' (Un\G302) is stored.

■Buffer memory address

The following table shows the buffer memory address of this area.

Buffer memory name	CH1	CH2	CH3	CH4
Automatic setting monitor at input range change	39			

Control mode selection

Select the control mode for each control group. The control groups are divided into control group 1 (channels 1 and 2) and control group 2 (channels 3 and 4), and share common settings within their group.

Normal mode	FX3 allocation mode
Set using bits 1 to 3 for each group.	Set using bits 1 to 3.
<p>Bit 15 14 13 12 11 10 9 8 7 6 5 4 3 2 1 0</p> <p>GR2 (bits 10-12) GR1 (bits 2-4)</p> <p>(1) (1)</p>	<p>Bit 15 14 13 12 11 10 9 8 7 6 5 4 3 2 1 0</p> <p>(1)</p>

(1) Set value	Control mode	Control types	Input	Output
000	0	Standard PID control	Internal	Internal
001	1	Standard PID control	External	Internal
010	2	Standard PID control	Internal	External
011	3	Standard PID control	External	External
100	4	Heating/cooling PID control	Internal	Internal
101	5	Heating/cooling PID control	External	Internal
110	6	Heating/cooling PID control	Internal	External
111	7	Heating/cooling PID control	External	External

- If the inputs are "internal", implement control using the process values detected by the internal inputs of the temperature control module.
- If the inputs are "external", implement control using the value stored in 'CH1 Temperature process value (PV) for input with another (external) analog module' (Un\G438). Temperature control module internal inputs are not used.
- If the outputs are "internal", implement control using the internal transistor outputs of the temperature control module.
- If the outputs are "external", implement control using the values stored in 'CH1 Manipulated value (MV) for output with another (external) analog module'/'CH1 Manipulated value for heating (MVh) for output with another (external) analog module' (Un\G407) and 'CH1 Manipulated value for cooling (MVc) for output with another (external) analog module' (Un\G409).

A

Point

- To enable the settings changes in normal mode, it is necessary to write the set values to buffer memory, and then to turn OFF→ON→OFF again the settings change command (Un\G399, b11).
- Control mode cannot be changed while implementing controls. If changed, the changes will be reflected when control stops.

■Buffer memory address

The following table shows the buffer memory address of this area.

Buffer memory name	CH1	CH2	CH3	CH4
	GR1		GR2	
Control mode selection	300			
Control mode selection (If using FX3 allocation mode)	240		241	

■Default value

Set to standard PID control (0).

Automatic setting at input range change

When "Channel 1 input range" (Un\G501) is changed, this function automatically changes the relevant buffer memory data to make sure that an outside settings range error (error code: 1950H) does not occur.

- 0: Disabled
- 1: Enabled

When Enable (1) has been set, the following buffer memory areas are automatically set or initialized when the setting of 'CH1 Input range' (Un\G501) is changed.

Buffer memory name	Default value	
	Standard PID control	Heating/cooling PID control
Set value (SV) setting (Un\G430)	0	0
(Heating) proportional band (Un\G431)	30	30
Alerts 1 to 4 settings (Un\G434 to 437)	0	0
(Cooling) proportional band (Un\G439)	—	30
Upper limit setting limiter (Un\G511)	Upper limit value of the input range	Upper limit value of the input range
Lower limit setting limiter (Un\G512)	Lower limit value of the input range	Lower limit value of the input range
Setting change rate limiter (Un\G513)	0	0
Adjustment sensitivity (dead band) setting (Un\G516)	10	10
Overlap/dead band (Un\G524)	—	0
Alert dead band setting (Un\G531)	10	10
Loop disconnection detection dead band (Un\G538)	0	0
AT bias (Un\G546)	0	0
Sensor compensation set value (Un\G565)	0	0

Point

If changing the input range in normal mode, it is necessary to turn OFF→ON→OFF again the settings change command (Un\G399, b11).

■Buffer memory address

The following table shows the buffer memory address of this area.

Buffer memory name	CH1	CH2	CH3	CH4
Automatic setting at input range change	302			

■Default value

Set to disabled (0).

SV tracking selection

If turning OFF cascade, this function tracks the slave channel set value in the set values immediately before switching (set value monitor value).

- 0: SV tracking OFF
- 1: SV tracking ON

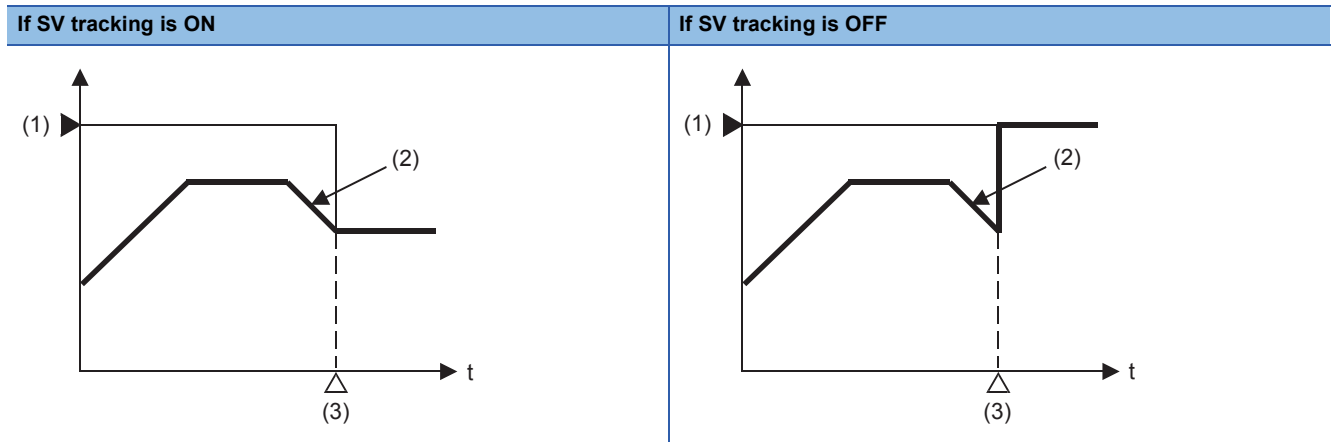

- (1) Slave channel set value (SV) setting
 (2) Slave channel set value monitor value
 (3) Cascade control ON→OFF switching point

Point

It is possible to prevent sudden changes to the slave channel manipulated value when turning OFF cascade.

Buffer memory address

The following table shows the buffer memory address of this area.

Buffer memory name	CH1	CH2	CH3	CH4
SV tracking selection	350		351	
SV tracking selection (If using FX3 allocation mode)	242		243	

Default value

Set to SV tracking ON (1).

Cascade ON/OFF

Turns ON and OFF cascade during cascade control.

- 0: Cascade OFF
- 1: Cascade ON

Point

During cascade control, auto tuning and startup tuning cannot be implemented.

Buffer memory address

The following table shows the buffer memory address of this area.

Buffer memory name	CH1	CH2	CH3	CH4
Cascade ON/OFF	352		353	
Cascade ON/OFF (If using FX3 allocation mode)	244		245	

Default value

Set to cascade OFF (0).

Cascade gain

During cascade control, gain is set when converting the master channel manipulated value (MV) to the cascade monitor value.

■Buffer memory address

The following table shows the buffer memory address of this area.

Buffer memory name	CH1	CH2	CH3	CH4
Cascade gain	354		355	
Cascade gain (If using FX3 allocation mode)	246		247	

■Setting range

Set to -10000 to +10000 ($\times -10.000$ to $\times +10.000$).

■Default value

Set to 1000 ($\times 1.000$).

Cascade bias

Sets the bias amount that is added to the sum of the master channel manipulated value (MV) and cascade gain during cascade control.

■Buffer memory address

The following table shows the buffer memory address of this area.

Buffer memory name	CH1	CH2	CH3	CH4
Cascade bias	356		357	
Cascade bias (If using FX3 allocation mode)	248		249	

■Setting range

Set to -1000 to +1000 (-100.0 to $+100.0\%$).

■Default value

The default value is 0.

Cascade monitor

Stores the master manipulated value (cascade signal) converted using 'cascade gain' and 'cascade bias' that is added to the slave set value during cascade control.

If 'cascade ON/OFF' is OFF (0), 0 is stored in the cascade monitor.

■Buffer memory address

The following table shows the buffer memory address of this area.

Buffer memory name	CH1	CH2	CH3	CH4
Cascade monitor	358		359	
Cascade monitor (If using FX3 allocation mode)	250		251	

Flag

Stores the temperature control module status in each bit.

■Buffer memory address

The following table shows the buffer memory address of this area.

Buffer memory name	CH1	CH2	CH3	CH4
Flag	360			
Flag (If using FX3 allocation mode)	0			

■Flag list

Bit	Description	Operation
b0	Error status	If 0: b1 to 10 are all 0 If any of 1: b1 to 10 is 1
b1	Settings range error status	0: No settings range error 1: Settings range error
b2	24 V DC power supply status	0: 24 V DC power supply normal 1: 24 V DC power supply error
b3	Set value backup error flag	0: Set value backup normal 1: Set value backup error
b4	Channel 1 AT/ST error completion flag	0: No error 1: Error finished
b5	Channel 2 AT/ST error completion flag	
b6	Channel 3 AT/ST error completion flag	
b7	Channel 4 AT/ST error completion flag	
b8	Adjustment data error	0: Adjustment data normal 1: Adjustment data error
b9	Cold contact temperature compensation data error	0: Cold contact temperature compensation normal for all channels 1: Cold contact temperature compensation error detected
b10	A/D converter error	0: A/D converter normal for all channels 1: A/D converter error detected
b11	Not used	—
b12	Control in operation flag	0: Control stopped 1: Control executing
b13	Set value backup flag	0: Set value backup stopped 1: Set value backup in operation
b14	Default completion flag	0: Default incomplete 1: Default complete
b15	Temperature adjustment READY flag* ¹	0: Temperature control module not READY 1: Temperature control module READY

*1 Once the power supply has been turned ON, the temperature adjustment READY flag turns ON after temperature control module initialization and auto diagnosis during startup is complete. FROM/TO commands (or direct buffer memory commands) are received only when the READY flag is ON.

Module information

FX5-4LC individual codes are stored.

- Normal mode: 61C0H
- FX3 allocation mode: 61C2H

■Buffer memory address

The following table shows the buffer memory address of this area.

Buffer memory name	CH1	CH2	CH3	CH4
Module information	397			
Module information (If using FX3 allocation mode)	30			

A

Input signal

The status of the temperature control module can be checked using buffer memory.

■ Buffer memory address

The following table shows the buffer memory address of this area.

Buffer memory name	CH1	CH2	CH3	CH4
Input signal	398			
Input signals (If using FX3 allocation mode)	0 to 4			

■ Input signals list

Buffer memory		Description
Input signal	Input signals (If using FX3 allocation mode)	
Un\G398, b0	Un\G0, b15	Module READY flag
Un\G398, b1	Un\G0, b12	Setting/operation mode status
Un\G398, b2	Un\G0, b0	Error flag
Un\G398, b3	—	Hardware error flag
Un\G398, b4	Un\G1, b14	CH1 Auto tuning status
Un\G398, b5	Un\G2, b14	CH2 Auto tuning status
Un\G398, b6	Un\G3, b14	CH3 Auto tuning status
Un\G398, b7	Un\G4, b14	CH4 Auto tuning status
Un\G398, b8	—	Set value backup completion flag
Un\G398, b9	Un\G0, b14	Default value write completion flag
Un\G398, b10	Un\G0, b3	Set value backup failure flag
Un\G398, b11	—	Setting change completion flag
Un\G398, b12	Un\G1, b4 to 9	CH1 Alert flag
Un\G398, b13	Un\G2, b4 to 9	CH2 Alert flag
Un\G398, b14	Un\G3, b4 to 9	CH3 Alert flag
Un\G398, b15	Un\G4, b4 to 9	CH4 Alert flag

■ Module READY flag (b0)

After the power supply is turned ON, this flag turns ON when the temperature control module is READY. After the power supply is turned ON, control is not performed for approx. 5 s.

■ Setting/operation mode status (b1)

This signal is ON in operation mode and OFF in setting mode.

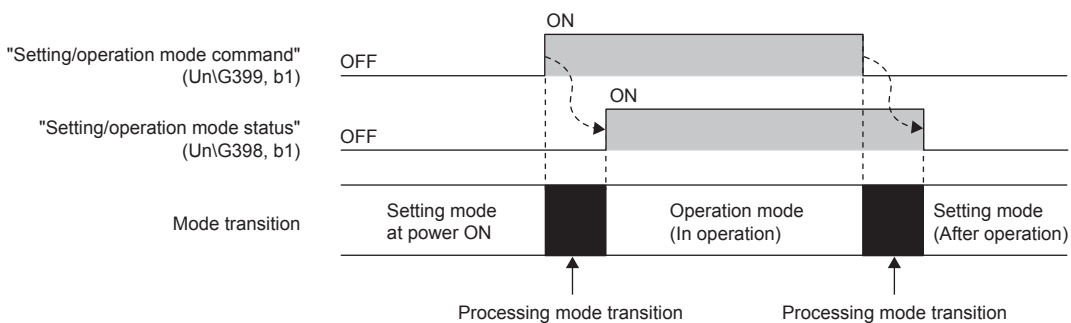

-----> Temperature control module will implement

■Error flag (b2)

This flag turns ON when an error other than a hardware error occurs.

After an error occurs and the error code of the error is stored in 'Latest error code' (Un\G0), this flag turns ON.

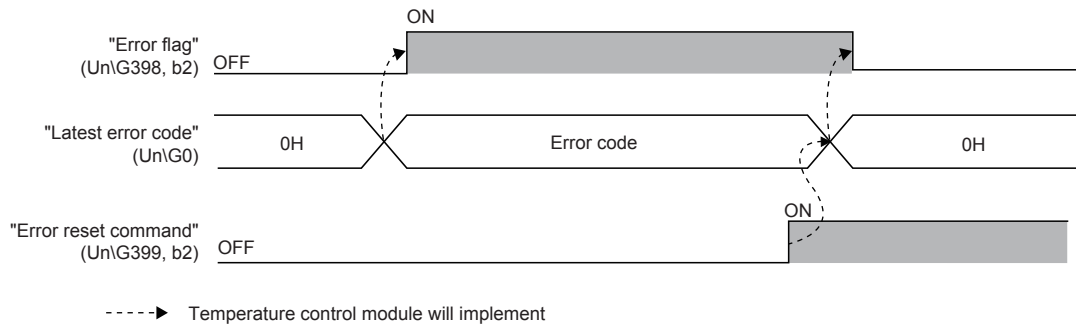

■Hardware error flag (b3)

This flag turns ON when a hardware failure occurs in the temperature control module.

■Auto tuning status (b4 to 7)

This flag turns ON when auto tuning is performed for each channel.

This signal is ON during the auto tuning, and automatically turns OFF at the completion of auto tuning.

■Set value backup completion flag (b8)

Turning OFF→ON 'Set value backup command' (Un\G399, b8) starts the writing of the data in the buffer memory to the non-volatile memory.

After the data writing is completed, this flag turns ON. Turning ON→OFF 'Set value backup command' (Un\G399, b8) also turns OFF this flag.

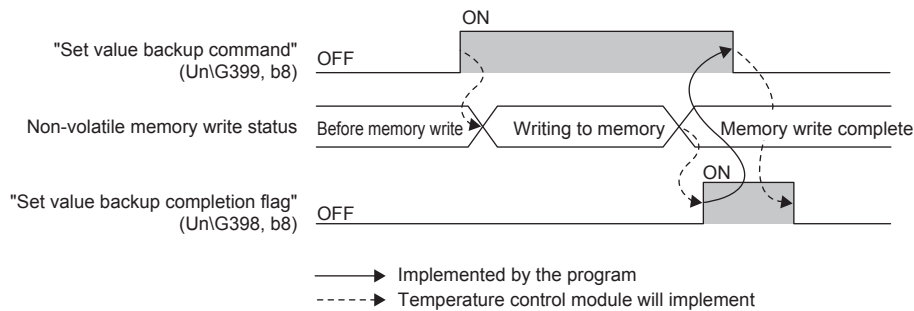

■Default value write completion flag (b9)

Turning OFF→ON 'Default setting registration command' (Un\G399, b9) starts the writing of the default value of the temperature control module to the buffer memory.

After the default value writing is completed, this flag turns ON.

■Set value backup failure flag (b10)

Turning OFF→ON 'Set value backup command' (Un\G399, b8) writes the data in the buffer memory to the non-volatile memory. This flag turns ON when the writing to the non-volatile memory has failed.



■Setting change completion flag (b11)

Turning OFF→ON 'Setting change command' (Un\G399, b11) updates the value set in each buffer memory area in the controls. After the data is reflected, this flag turns ON. Turning ON→OFF 'Setting change command' (Un\G399, b11) also turns OFF this flag.

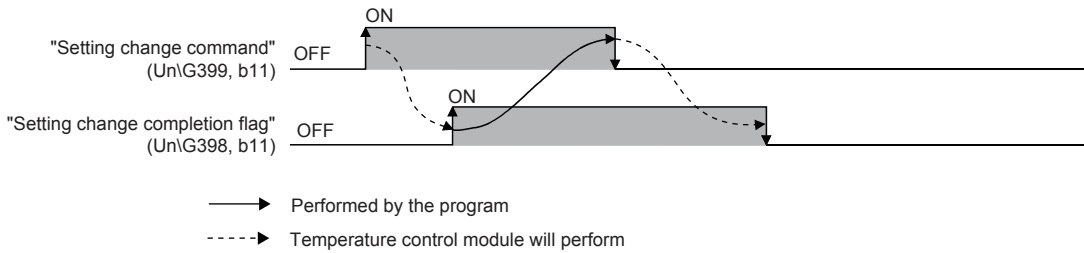

■Alert flag (b12 to 15)

When an alert has occurred in CH1 to 4, the alert definition is stored in 'CH1 to 4 Alert definition' (Un\G401, 601, 801, 1001), and this flag turns ON.

Output signal

Sets the control commands from the temperature control module in buffer memory.

■Buffer memory address

The following table shows the buffer memory address of this area.

Buffer memory name	CH1	CH2	CH3	CH4
Output signal	399			
Output signals (If using FX3 allocation mode)	29, 56, 96, 136, 176, 253 to 255			

■Output signals list

Buffer memory		Description
Output signal	Output signals (If using FX3 allocation mode)	
Un\G399, b0	—	System area
Un\G399, b1	Un\G29	Setting/operation mode command
Un\G399, b2	Un\G253	Error reset command
Un\G399, b3	—	System area
Un\G399, b4	Un\G56	CH1 Auto tuning command
Un\G399, b5	Un\G96	CH2 Auto tuning command
Un\G399, b6	Un\G136	CH3 Auto tuning command
Un\G399, b7	Un\G176	CH4 Auto tuning command
Un\G399, b8	Un\G254	Set value backup command
Un\G399, b9	Un\G255	Default setting registration command
Un\G399, b10	—	System area
Un\G399, b11	—	Setting change command
Un\G399, b12	—	System area
Un\G399, b13	—	System area
Un\G399, b14	—	System area
Un\G399, b15	—	System area

■Setting/operation mode command (b1)

Use this signal to select the setting mode or the operation mode.

- 0: Setting mode
- 1: Operation mode

■Error reset command (b2)

Turning OFF→ON the error reset command resets the following information.

- Latest error code
- Error occurrence address (Settings range error address)
- Latest alarm code
- Input signals error occurrence flag (Un\G398, b2)
- Flags error flag (Un\G360, b0 to 10)

■Auto tuning command (b4 to 7)

Use this signal to start the auto tuning for each channel. Turning OFF→ON 'CH1 Auto tuning command' (Un\G399, b4) starts the auto tuning and turns OFF→ON 'CH1 Auto tuning status' (Un\G398, b4). After the auto tuning is completed, 'CH1 Auto tuning status' (Un\G398, b4) turns ON→OFF.

After auto tuning is completed, turn ON→OFF 'CH1 Auto tuning command' (Un\G399, b4) .

■Set value backup command (b8)

Use this signal to write the data in the buffer memory to the non-volatile memory. Turning OFF→ON this command starts the data writing to the non-volatile memory.

For the buffer memory areas whose data is to be backed up, refer to the following.

☞ Page 99 List of buffer memory addresses

After backup is complete, store 0 in 'Set value backup command' (Un\G399, b8).

Precautions

- If a settings error occurs, backup cannot be implemented.
- Do not change the buffer memory during backup.

■Default setting registration command (b9)

- Normal mode

Turning OFF→ON 'Default setting registration command' (Un\G399, b9) returns the data in the buffer memory to the default values according to the control mode settings. After the data writing is completed, 'Default value write completion flag' (Un\G398, b9) turns ON.

Turning ON→OFF the 'Default setting registration command' (Un\G399, b9) also turns OFF the 'Default value write completion flag' (Un\G398, b9).

- FX3 allocation mode

Writing 1 to the 'Default setting registration command' (Un\G255) restores all data in the buffer memory to the default values according to the settings. Writing 2 restores Un\G48 to 207, 232, and 242 to 255 to the default values according to the settings. When writing is complete, the 'Default setting registration command' (Un\G255) becomes 0.

When the 'Default setting registration command' (Un\G255) becomes 0, the 'default value write completion flag' (Un\G0, b14) turns ON for approx. 250 ms.

■Setting change command (b11)

Use this command to enable the set value in following buffer memory.

- Input range (Un\G501)
- Alerts 1 to 4 mode settings (Un\G533 to 536)
- Control mode selection (Un\G300)
- Transistor output functions selection (Un\G597)

Even though the set values are written into the buffer memory, they are not immediately reflected to the temperature control module's operation.

To validate the set values, turn OFF→ON→OFF this command after the set values are written into the buffer memory.

Turning OFF→ON→OFF this command operates the temperature control module according to the setting in each buffer memory area.

Point

- This device can be used as an interlock of 'Setting/operation mode command' (Un\G399, b1).
- Turn OFF→ON the settings change command while control is stopped.

CH1 Decimal point position

Depending on the setting of 'CH1 Input range' (Un\G501), the decimal point position applicable in the following buffer memory areas is stored in this area.

- 'CH1 Temperature process value (PV)' (Un\G402)
- 'CH1 Set value (SV) setting' (Un\G430)
- 'CH1 Proportional band (P) setting' (Un\G431)
- 'CH1 Alert set value 1 to 4'(Un\G434 to 437)
- 'CH1 Cooling proportional band (Pc) setting' (Un\G439)
- 'CH1 Upper limit setting limiter' (Un\G511)
- 'CH1 Lower limit setting limiter' (Un\G512)
- 'CH1 Setting change rate limiter' (Un\G513)
- 'CH1 Adjustment sensitivity (dead band) setting' (Un\G516)
- 'CH1 Overlap/dead band setting' (Un\G524)
- 'CH1 Alert dead band setting' (Un\G531)
- 'CH1 Loop disconnection detection dead band' (Un\G538)
- 'CH1 AT bias' (Un\G546)
- 'CH1 Sensor correction value setting' (Un\G565)

Stored values depend on the setting in 'CH1 Input range' (Un\G501).

'CH1 Input range' (Un\G501)	Stored value	Setting details
When the resolution is 1	0	No decimal point
When the resolution is 0.1	1	First decimal place

■ Buffer memory address







The following table shows the buffer memory address of this area.

Buffer memory name	CH1	CH2	CH3	CH4
CH□ Decimal point position	400	600	800	1000
CH□ Decimal point position (If using FX3 allocation mode)	1 (b12) ^{*1}	2 (b12) ^{*1}	3 (b12) ^{*1}	4 (b12) ^{*1}

*1 For details, refer to  Page 134 CH1 Event.

CH1 Alert definition

Bits corresponding to alerts detected turn ON.

Bit No.	Flag name	Alert definition
b0	CH1 Input range upper limit	When the temperature process value (PV) has exceeded the temperature measuring range of the set input range.
b1	CH1 Input range lower limit	When the temperature process value (PV) is below the temperature measuring range of the set input range.
b2 to b7	—	—
b8	CH1 alert 1	When Alert 1 has occurred. ( Page 54 Alert Function)
b9	CH1 alert 2	When Alert 2 has occurred. ( Page 54 Alert Function)
b10	CH1 alert 3	When Alert 3 has occurred. ( Page 54 Alert Function)
b11	CH1 alert 4	When Alert 4 has occurred. ( Page 54 Alert Function)
b12	CH1 Heater disconnection detection	When a heater disconnection has been detected. ( Page 63 Heater Disconnection Detection Function)
b13	CH1 Loop disconnection detection	When a loop disconnection has been detected. ( Page 61 Loop Disconnection Detection Function)
b14	CH1 Output off-time current error	When an output off-time current error has been detected. ( Page 63 Output OFF-time Current Error Detection Function)
b15	—	—

■ Buffer memory address

The following table shows the buffer memory address of this area.

Buffer memory name	CH1	CH2	CH3	CH4
CH□ Alert definition	401	601	801	1001
CH□ Alert definition (If using FX3 allocation mode)	1*1	2*1	3*1	4*1

*1 For details, refer to  Page 134 CH1 Event.

CH1 Temperature process value (PV)

The values that implemented the following processes are stored in the detected temperature values.

- Linearize process*1
- Sensor process
- Primary Delay Digital Filter

*1 Not implemented when using external (other analog module) inputs.

The value to be stored differs depending on the value stored in 'CH1 Decimal point position' (Un\G400). ( Page 128 CH1 Decimal point position)

- If there is nothing after the decimal point (0): Stored as is.
- If there is 1 digit after the decimal point (1): The $\times 10$ value is stored.

Point

One of the following values is stored depending on the input type.

- Internal temperature inputs: Input range lower limit-5% of span to input range upper limit+5% of span
- Internal low-voltage inputs: Scaling lower limit-5% of span to scaling upper limit+5% of span
- External inputs: External input range lower limit-5% of span to external input range upper limit+5% of span

■ Buffer memory address

The following table shows the buffer memory address of this area.

Buffer memory name	CH1	CH2	CH3	CH4
CH□ Temperature process value (PV)	402	602	802	1002
CH□ Temperature process value (PV) (If using FX3 allocation mode)	5	6	7	8

CH1 Manipulated value (MV)

The manipulated value is stored either as a result of PID calculations or during MAN mode.

Range of values to be stored during control	Value to be stored while the control has stopped
Lower limit output limiter value to upper limit output limiter value	-50 (-5.0%)

■ Buffer memory address

The following table shows the buffer memory address of this area.

Buffer memory name	CH1	CH2	CH3	CH4
CH□ Manipulated value (MV)	403	603	803	1003
CH□ Manipulated value (MV) (If using FX3 allocation mode)	9	10	11	12

CH1 Manipulated value for heating (MVh)

Stores the manipulated value for heating of the results of the heating/cooling PID calculation.

Range of values to be stored during control	Value to be stored while the control has stopped
0 to heating upper limit output limiter value	-50 (-5.0%)

■ Buffer memory address

The following table shows the buffer memory address of this area.

Buffer memory name	CH1	CH2	CH3	CH4
CH□ Manipulated value for heating (MVh)	403	603	803	1003
CH□ Manipulated value for heating (MVh) (If using FX3 allocation mode)	9	10	11	12

CH1 Temperature rise judgment flag

This flag is for checking whether or not the temperature process value (PV) is within the temperature rise completion range. One of the following values is stored in this area.

- OFF: Outside the temperature rise completion range
- ON: Within the temperature rise completion range

When the temperature process value (PV) stays within the temperature rise completion range during the set temperature rise completion soak time, Within temperature rise completion range (ON) is stored in this buffer memory area.

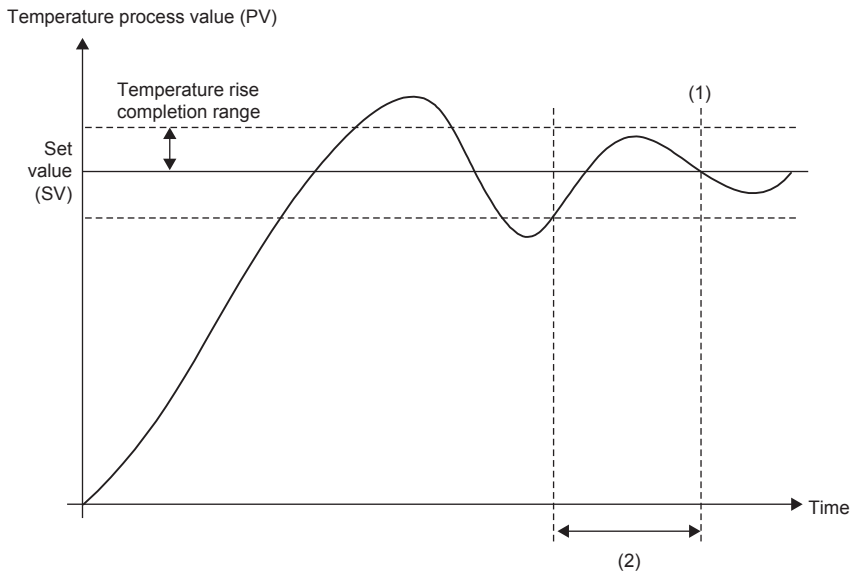

(1) At this time, 'CH1 Temperature rise judgment flag' (Un\G404) is set to Within temperature rise completion range (ON).

(2) 'CH1 Temperature rise completion soak time setting' (Un\G507)

Set the temperature rise completion range and the temperature rise completion soak time in the following buffer memory areas.

- 'CH1 Temperature rise completion range setting' (Un\G506) (Page 143 CH1 Temperature rise completion range setting)
- 'CH1 Temperature rise completion soak time setting' (Un\G507) (Page 144 CH1 Temperature rise completion soak time setting)

■Buffer memory address

The following table shows the buffer memory address of this area.

Buffer memory name	CH1	CH2	CH3	CH4
CH□ Temperature rise judgment flag	404	604	804	1004
CH□ Temperature rise judgment flag (If using FX3 allocation mode)	1 (b15) ^{*1}	2 (b15) ^{*1}	3 (b15) ^{*1}	4 (b15) ^{*1}

*1 For details, refer to Page 134 CH1 Event.

CH1 Transistor output flag (Control output flag)

Stores the ON/OFF status of the transistor outputs.

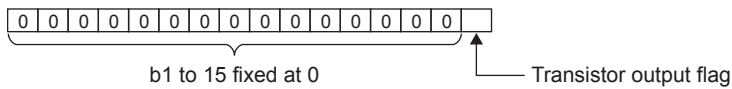

Control mode selection (Un\G300)	Transistor output functions selection (Un\G597)	Transistor output flag contents (b0)
0 to 1	—	Transistor output status
2 to 3	0	Time proportional calculation results
	1 to 2	Transistor output status
	3 to 7	Time proportional calculation results

■Buffer memory address

The following table shows the buffer memory address of this area.

Buffer memory name	CH1	CH2	CH3	CH4
CH□ Transistor output flag	405	605	805	1005
CH□ Transistor output flag (If using FX3 allocation mode)	17	18	19	20

CH1 Heating transistor output flag

Stores the ON/OFF status of the transistor outputs.

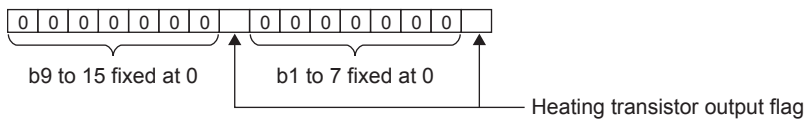

Control mode selection (Un\G300)	Transistor output functions selection (Un\G597)	Channel	Heating transistor output flag contents	
			b8*1	b0
4 to 5	—	1, 3	Cooling transistor output status	Heating transistor output status
	—	2, 4	Cooling output time proportional calculation results	Heating output time proportional calculation results
6 to 7	0	—	Cooling output time proportional calculation results	Heating output time proportional calculation results
	1	—	Cooling output time proportional calculation results	Heating transistor output status
	2	—	Cooling transistor output status	Heating output time proportional calculation results
	3 to 7	—	Cooling output time proportional calculation results	Heating output time proportional calculation results

*1 b8 is used only in FX3 allocation mode. Normal mode refer to CH1 Cooling transistor output flag.

■Buffer memory address

The following table shows the buffer memory address of this area.

Buffer memory name	CH1	CH2	CH3	CH4
CH□ Heating transistor output flag	405	605	805	1005
CH□ Heating transistor output flag (If using FX3 allocation mode)	17	18	19	20

CH1 Set value (SV) monitor

Stores the set values used by PID control and alert functions.

It is possible to monitor excessive changes to the slave set values during "Setting change rate limiter" settings and cascade control.

■Buffer memory address

The following table shows the buffer memory address of this area.

Buffer memory name	CH1	CH2	CH3	CH4
CH□ Set value (SV) monitor	406	606	806	1006
CH□ Set value (SV) monitor (If using FX3 allocation mode)	40	41	42	43

CH1 Manipulated value (MV) for output with another (external) analog module

Scales and stores the values stored in the following buffer memory after output limiting process in the external outputs range when implementing control using external outputs.

Buffer memory name	Buffer memory address	Reference
CH1 Manipulated value (MV)	403	Page 129 CH1 Manipulated value (MV)

■Buffer memory address

The following table shows the buffer memory address of this area.

Buffer memory name	CH1	CH2	CH3	CH4
CH□ Manipulated value (MV) for output with another (external) analog module	407	607	807	1007
CH□ Manipulated value (MV) for output with another (external) analog module (If using FX3 allocation mode)	32	33	34	35

CH1 Manipulated value for heating (MVh) for output with another (external) analog module

Scales and stores the values stored in the following buffer memory after output limiting process in the external outputs range when implementing control using external outputs.

Buffer memory name	Buffer memory address	Reference
CH1 Manipulated value for heating (MVh)	403	Page 129 CH1 Manipulated value for heating (MVh)

■Buffer memory address

The following table shows the buffer memory address of this area.

Buffer memory name	CH1	CH2	CH3	CH4
CH□ Manipulated value for heating (MVh) for output with another (external) analog module	407	607	807	1007
CH□ Manipulated value for heating (MVh) for output with another (external) analog module (If using FX3 allocation mode)	32	33	34	35

CH1 Manipulated value for cooling (MVc)

Stores the manipulated value for cooling of the results of the heating/cooling PID calculation.

Range of values to be stored during control	Value to be stored while the control has stopped
0 to cooling upper limit output limiter value	-50(-5.0%)

■Buffer memory address

The following table shows the buffer memory address of this area.

Buffer memory name	CH1	CH2	CH3	CH4
CH□ Manipulated value for cooling (MVc)	408	608	808	1008
CH□ Manipulated value for cooling (MVc) (If using FX3 allocation mode)	13	14	15	16

CH1 Manipulated value for cooling (MVc) for output with another (external) analog module

Scales and stores the values stored in the following buffer memory after output limiting process in the external outputs range when implementing control using external outputs.

Buffer memory name	Buffer memory address	Reference
CH1 Manipulated value for cooling (MVc)	408	Page 133 CH1 Manipulated value for cooling (MVc)

■Buffer memory address

The following table shows the buffer memory address of this area.

Buffer memory name	CH1	CH2	CH3	CH4
CH□ Manipulated value for cooling (MVc) for output with another (external) analog module	409	609	809	1009
CH□ Manipulated value for cooling (MVc) for output with another (external) analog module (If using FX3 allocation mode)	36	37	38	39

CH1 Cooling transistor output flag

Stores the ON/OFF status of the transistor outputs.

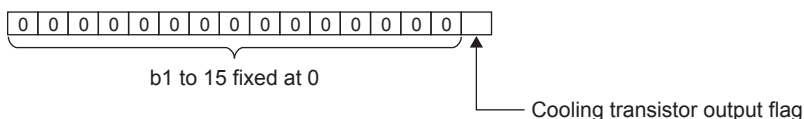

Control mode selection (UnG300)	Transistor output functions selection (UnG597)	Channel	Transistor output flag contents (b0)
4 to 5	—	1, 3	Cooling transistor output status
	—	2, 4	Cooling output time proportional calculation results
6 to 7	0	—	Cooling output time proportional calculation results
	1	—	Cooling output time proportional calculation results
	2	—	Cooling transistor output status
	3 to 7	—	Cooling output time proportional calculation results

■Buffer memory address

The following table shows the buffer memory address of this area.

Buffer memory name	CH1	CH2	CH3	CH4
CH□ Cooling transistor output flag ^{*1}	410	610	810	1010

*1 If using FX3 allocation mode, refer to CH1 Heating transistor output flag.

CH1 Event

Stores the channel statuses in each bit.

Bit No.	Description	Operation
b0	Input error (upper limit) status	OFF: No input error (upper limit) ON: Input error (upper limit) detected
b1	Input error (lower limit) status	OFF: No input error (lower limit) ON: Input error (lower limit) detected
b2	Cold contact temperature compensation status	OFF: Cold contact temperature compensation normal ON: Cold contact temperature compensation error detected
b3	A/D converter status	OFF: A/D converter normal ON: A/D converter error detected
b4	Alert 1 status	OFF: Alert 1 normal ON: Alert 1 occurred
b5	Alert 2 status	OFF: Alert 2 normal ON: Alert 2 occurred
b6	Alert 3 status	OFF: Alert 3 normal ON: Alert 3 occurred
b7	Alert 4 status	OFF: Alert 4 normal ON: Alert 4 occurred
b8	Loop disconnection alert status	OFF: Loop disconnection alert normal ON: Loop disconnection alert occurred
b9	Heater disconnection alert status	OFF: Heater disconnection alert normal ON: Heater disconnection alert occurred
b10	Current error status while outputs are OFF	OFF: Current error while outputs are OFF not detected ON: Current error while outputs are OFF occurred
b11	ST implementation status	OFF: ST stopped ON: ST implementing
b12	Decimal point position	OFF: $\times 1^{\circ}\text{C}/^{\circ}\text{F}$ For digit ON: $\times 0.1^{\circ}\text{C}/^{\circ}\text{F}$
b13	Manual mode shift completion flag	OFF: No AUTO mode or MAN mode shift ON: MAN mode shift complete
b14	AT implementation status	OFF: AT stopped ON: AT implementing
b15	Temperature rise completion status	OFF: Temperature rise incomplete ON: Temperature rise complete

■ Buffer memory address

The following table shows the buffer memory address of this area.

Buffer memory name	CH1	CH2	CH3	CH4
Event	429	629	829	1029
Event (If using FX3 allocation mode)	1	2	3	4

CH1 Set value (SV) setting

Sets the PID control and alert process set values.

■Buffer memory address

The following table shows the buffer memory address of this area.

Buffer memory name	CH1	CH2	CH3	CH4
CH□ Set value (SV) setting	430	630	830	1030
CH□ Set value (SV) setting (If using FX3 allocation mode)	48	88	128	168

■Setting range

The range is determined by the values set in 'CH1 Upper limit setting limiter' (Un\G511) and 'CH1 Lower limit setting limiter' (Un\G512). ( Page 147 CH1 Upper limit setting limiter, Page 147 CH1 Lower limit setting limiter)

When a value out of the setting range is set in this area, an out of setting range error (error code: 1950H) occurs, and the status is as described below.

- 'Error flag' (Un\G398, b2) turns ON.
- An error code is stored in 'Latest error code' (Un\G0).

■Setting unit

The value to be set differs depending on the value stored in 'CH1 Decimal point position' (Un\G400). ( Page 128 CH1 Decimal point position)

- No decimal point (0): Set a value in increments of 1°C (°F or digit).
- If there is 1 digit (1) past the decimal point: Set a value (the value multiplied by 10) in increments of 0.1°C (°F).

■Default value

The default value is 0.

CH1 Proportional band (P) setting

Set the proportional band (P) to execute the standard PID control.

■Buffer memory address

The following table shows the buffer memory address of this area.

Buffer memory name	CH1	CH2	CH3	CH4
CH□ Proportional band (P) setting	431	631	831	1031
CH□ Proportional band (P) setting (If using FX3 allocation mode)	58	98	138	178

■Setting range

0 to 10000 (span^{*1} 0.0 to 1000.0%)

*1 During internal temperature inputs, input range span. During internal micro voltage inputs, scaling span. During external inputs, external input span.

■Two-position control

Set the proportional band (P) to 0.

For details on the two-position control, refer to the following.

 Page 26 Control Method

■Default value

The default value is 30 (3.0%).

CH1 Heating proportional band (Ph) setting

Set the heating proportional band (Ph) to implement the heating and cooling PID control.

■Buffer memory address

The following table shows the buffer memory address of this area.

Buffer memory name	CH1	CH2	CH3	CH4
CH□ Heating proportional band (Ph) setting	431	631	831	1031
CH□ Heating proportional band (Ph) setting (If using FX3 allocation mode)	58	98	138	178

■Setting range

0 to 10000 (span^{*1} 0.0 to 1000.0%)

*1 During internal temperature inputs, input range span. During internal micro voltage inputs, scaling span. During external inputs, external input span.

■Two-position control

Set the heating proportional band (Ph) to 0.

For details on the two-position control, refer to the following.

☞ Page 26 Control Method

■Default value

The default value is 30 (3.0%).

CH1 Integral time (I) setting

Set the integral time (I) to execute the PID control.

■Buffer memory address

The following table shows the buffer memory address of this area.

Buffer memory name	CH1	CH2	CH3	CH4
CH□ Integral time (I) setting	432	632	832	1032
CH□ Integral time (I) setting (If using FX3 allocation mode)	60	100	140	180

■Setting range

The setting range is 0 to 3600 (0 to 3600s).

■P control or PD control

Set 0. For details on control methods, refer to the following.

☞ Page 26 Control Method

■Default value

The default value is 240 (240s).

CH1 Derivative time (D) setting

Set the derivative time (D) to execute the PID control.

■Buffer memory address

The following table shows the buffer memory address of this area.

Buffer memory name	CH1	CH2	CH3	CH4
CH□ Differential time (D) setting	433	633	833	1033
CH□ Differential time (D) setting (If using FX3 allocation mode)	61	101	141	181

■Setting range

The setting range is 0 to 3600 (0 to 3600s).

■P control or PI control

Set 0. For details on control methods, refer to the following.

☞ Page 26 Control Method

■Default value

The default value is 60 (60s).

CH1 Alert set value 1

Set the temperature to turn ON CH1 alert 1 (Un\G401, b8) according to the selected alert 1 'alert mode' (Un\G533).

For 'CH1 Warning Occurrence Contents' (Un\G401), refer to the following.

☞ Page 128 CH1 Alert definition

For details of the alert function, refer to the following.

☞ Page 54 Alert Function

■Buffer memory address

The following table shows the buffer memory address of this area.

Buffer memory name	CH1	CH2	CH3	CH4
CH□ Alert set value 1	434	634	834	1034
CH□ Alert set value 1 (If using FX3 allocation mode)	49	89	129	169

■Alert mode

Set the alert mode of Alert 1 in the following buffer memory area. The alert mode of Alert 1 corresponds to 'CH1 Alert set value 1' (Un\G434).

- 'CH1 Alert 1 mode setting' (Un\G533)

■Setting range

The write set value units and settings range depend on the alert mode that has been set.

Alert mode	Setting range of alert set value	Remarks
No alert	0	—
Upper limit input alert, lower limit input alert	Same as the input range.*1	Same as with wait.
Upper limit deviation alert, lower limit deviation alert	- span to + span*2	Same as with wait and re-wait.
Upper/lower limit deviation alert, within range alert	0 to + span*2	Same as with wait and re-wait.

*1 During internal temperature inputs, input range. During internal micro voltage inputs, scaling range. During external inputs, external input range.

*2 During internal temperature inputs, input range span. During internal micro voltage inputs, scaling span. During external inputs, external input span.

■Setting unit

The value to be set differs depending on the value stored in 'CH1 Decimal point position' (Un\G400). ( Page 128 CH1 Decimal point position)

- No decimal point (0): Set a value in increments of 1°C (°F or digit).
- If there is 1 digit (1) past the decimal point: Set a value (the value multiplied by 10) in increments of 0.1°C (°F).

■Default value

The default value is 0.

CH1 Alert set value 2

Set the temperature to turn ON CH1 alert 2 (Un\G401, b9) according to the selected alert 2 'alert mode' (Un\G533).

For 'CH1 Warning Occurrence Contents' (Un\G401), refer to the following.

 Page 128 CH1 Alert definition

For details of the alert function, refer to the following.

 Page 54 Alert Function

■Buffer memory address

The following table shows the buffer memory address of this area.

Buffer memory name	CH1	CH2	CH3	CH4
CH□ Alert set value 2	435	635	835	1035
CH□ Alert set value 2 (If using FX3 allocation mode)	50	90	130	170

■Alert mode

Set the alert mode of Alert 2 in the following buffer memory area. The alert mode of Alert 2 corresponds to 'CH1 Alert set value 2' (Un\G435).

- 'CH1 Alert 2 mode setting' (Un\G534)

■Setting range

For the settings range, refer to the following.

 Page 137 Setting range

■Setting unit

For the settings unit, refer to the following.

 Page 138 Setting unit

■Default value

The default value is 0.

CH1 Alert set value 3

Set the temperature to turn ON CH1 alert 3 (Un\G401, b10) according to the selected alert 3 'alert mode' (Un\G533).

For 'CH1 Warning Occurrence Contents' (Un\G401), refer to the following.

☞ Page 128 CH1 Alert definition

For details of the alert function, refer to the following.

☞ Page 54 Alert Function

■Buffer memory address

The following table shows the buffer memory address of this area.

Buffer memory name	CH1	CH2	CH3	CH4
CH□ Alert set value 3	436	636	836	1036
CH□ Alert set value 3 (If using FX3 allocation mode)	51	91	131	171

■Alert mode

Set the alert mode of Alert 3 in the following buffer memory area. The alert mode of Alert 3 corresponds to 'CH1 Alert set value 3' (Un\G436).

- 'CH1 Alert 3 mode setting' (Un\G535)

■Setting range

For the settings range, refer to the following.

☞ Page 137 Setting range

■Setting unit

For the settings unit, refer to the following.

☞ Page 138 Setting unit

■Default value

The default value is 0.

CH1 Alert set value 4

Set the temperature to turn ON CH1 alert 4 (Un\G401, b11) according to the selected alert 4 'alert mode' (Un\G533).

For 'CH1 Warning Occurrence Contents' (Un\G401), refer to the following.

☞ Page 128 CH1 Alert definition

For details of the alert function, refer to the following.

☞ Page 54 Alert Function

■Buffer memory address

The following table shows the buffer memory address of this area.

Buffer memory name	CH1	CH2	CH3	CH4
CH□ Alert set value 4	437	637	837	1037
CH□ Alert set value 4 (If using FX3 allocation mode)	52	92	132	172

■Alert mode

Set the alert mode of Alert 4 in the following buffer memory area. The alert mode of alert 4 corresponds to 'CH1 alert set value 4' (Un\G437).

- 'CH1 Alert 4 mode setting' (Un\G536)

■Setting range

For the settings range, refer to the following.

☞ Page 137 Setting range

■Setting unit

For the setting unit, refer to the following.

☞ Page 138 Setting unit

■Default value

The default value is 0.

CH1 Temperature process value (PV) for input with another (external) analog module

The digital input value of the current or voltage converted in another analog module on the system can be used as a temperature process value (PV). Store the digital input value of the current or voltage converted by another analog module in this area. For details, refer to the following.

☞ Page 50 Input

Precautions

- If a greater value than (external input range upper limit +5% of external input range) is set, an input upper limit alert occurs, and 'CH1 event' (Un\G429) b0 turns ON.
- If a smaller value than (external input range lower limit -5% of external input range) is set, an input lower limit alert occurs, and 'CH1 event' (Un\G429) b1 turns ON.

■Buffer memory address

The following table shows the buffer memory address of this area.

Buffer memory name	CH1	CH2	CH3	CH4
CH□ Temperature process value (PV) for input with another (external) analog module	438	638	838	1038
CH□ Temperature process value (PV) for input with another (external) analog module (If using FX3 allocation mode)	25	26	27	28

■Default value

The default value is 0.

CH1 Cooling proportional band (Pc) setting

Set the cooling proportional band (Pc) to implement the heating and cooling PID control.

■Buffer memory address

The following table shows the buffer memory address of this area.

Buffer memory name	CH1	CH2	CH3	CH4
CH□ Cooling proportional band (Pc) setting	439	639	839	1039
CH□ Cooling proportional band (Pc) setting (If using FX3 allocation mode)	59	99	139	179

■Setting range

1 to 10000 (span^{*1} 0.1 to 1000.0%)

*1 During internal temperature inputs, input range span. During internal micro voltage inputs, scaling span. During external inputs, external input span.

■Default value

The default value is 30 (3.0%).

CH1 Input range

Select the input type used by the temperature control module.

■Buffer memory address

The following table shows the buffer memory address of this area.

Buffer memory name	CH1	CH2	CH3	CH4
CH□ Input range	501	701	901	1101
CH□ input range (If using FX3 allocation mode)	208	214	220	226

■Setting value and type of thermocouple

The following table lists the set values of 'CH1 Input range' (Un\G501) and the corresponding temperature sensor types.

Setting value	Temperature sensor type	Temperature measuring range	Resolution	Unit
0	K	-200.0 to +200.0	0.1	°C
1		-100.0 to +400.0	0.1	°C
2		-100 to +1300	1	°C
3		-100 to +800	1	°F
4	J	-100 to +2400	1	°F
5		-200.0 to +200.0	0.1	°C
6		-100.0 to +400.0	0.1	°C
7		-100.0 to +800.0	0.1	°C
8		-100 to +1200	1	°C
9		-100 to +1600	1	°F
10	R	-100 to +2100	1	°F
11		0 to 1700	1	°C
12	S	0 to 3200	1	°F
13		0 to 1700	1	°C
14	E	0 to 3200	1	°F
15		-200.0 to +200.0	0.1	°C
16		0 to 1000	1	°C
17	T	0 to 1800	1	°F
18		-200.0 to +200.0	0.1	°C
19		-200.0 to +400.0	0.1	°C
20		0.0 to 400.0	0.1	°C
21		-300.0 to +400.0	0.1	°F
22	B	-300.0 to +700.0	0.1	°F
23		0.0 to 700.0	0.1	°F
24		0 to 1800	1	°C
25	N	0 to 3000	1	°F
26		0 to 1300	1	°C
27	PL II	0 to 2300	1	°F
28		0 to 1200	1	°C
29	W5Re/W26Re	0 to 2300	1	°F
30		0 to 3000	1	°C
31	U	0 to 2300	1	°F
32		-200.0 to +600.0	0.1	°C
33	L	-300.0 to +700.0	0.1	°F
34		0.0 to 900.0	0.1	°C
35	Jpt100	0 to 1600	1	°F
36		-50.0 to +150.0	0.1	°C
37		-200.0 to +500.0	0.1	°C
38		-300.0 to +300.0	0.1	°F
39	Pt100	300 to 900	1	°F
40		-50.0 to +150.0	0.1	°C
41		-200.0 to +600.0	0.1	°C
42		-300.0 to +300.0	0.1	°F
43	Pt1000	-300 to +1100	1	°F
44		-200.0 to +650.0	0.1	°C
45	Low voltage	-328 to +1184	1	°F
46		0 to 10	1	mV
47		0 to 100	1	mV

■Enabling the settings

If changing the settings, turn OFF→ON→OFF the 'Settings change command' (Un\G399, b11) in normal mode to enable the settings contents.

Precautions

Settings cannot be changed while implementing controls. If changed during control implementation, the settings contents will be reflected when control stops.

■Default value

The default value is 2.

CH1 Control output cycle setting

Sets the control output cycle (time proportional cycle).

Manipulated value (MV) ON time and OFF time are each as described below.

- ON time: Control output cycle (s) × manipulated value (%)
- OFF time: Control output cycle (s) × (100 - manipulated value (%))

Ex.

If control output cycle: 30 s/manipulated value (MV): 60%

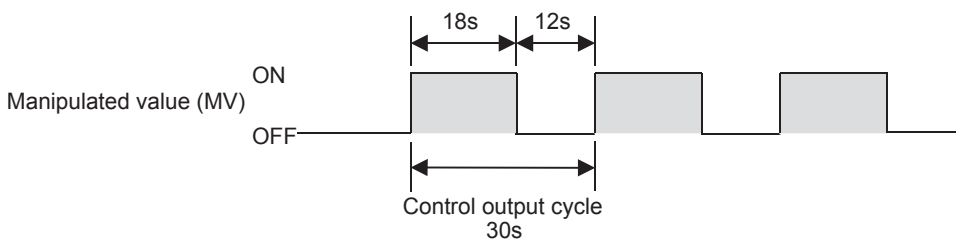

■Buffer memory address

The following table shows the buffer memory address of this area.

Buffer memory name	CH1	CH2	CH3	CH4
CH□ Control output cycle setting	504	704	904	1104
CH□ Control output cycle setting (If using FX3 allocation mode)	70	110	150	190

■Setting range

5 to 1000 (0.5 to 100.0s)

■Default value

300 (30.0s)

CH1 Heating control output cycle setting

Sets the heating control output cycle (time proportional cycle).

Manipulated value for heating (MVh) ON time and OFF time are each as described below.

- ON time: Heating control output cycle (s) × manipulated value for heating (%)
- OFF time: Heating control output cycle (s) × (100 - manipulated value for heating (%))

For details, refer to [Page 142 CH1 Control output cycle setting](#).

■Buffer memory address

The following table shows the buffer memory address of this area.

Buffer memory name	CH1	CH2	CH3	CH4
CH□ Heating control output cycle setting	504	704	904	1104
CH□ Heating control output cycle setting (If using FX3 allocation mode)	70	110	150	190

CH1 Control response parameter

In the simple two-degree-of-freedom PID control, select the response speed to the change of the set value (SV) from the following three levels:

Slow, Normal, and Fast.

☞ Page 32 Simple Two-degree-of-freedom

■ Buffer memory address

The following table shows the buffer memory address of this area.

Buffer memory name	CH1	CH2	CH3	CH4
CH□ Control response parameter	505	705	905	1105
CH□ Control response parameter (If using FX3 allocation mode)	62	102	142	182

■ Setting range

Setting value	Setting detail	Description
0	Slow	Set this value when reducing the overshoot and undershoot to the change of the set value (SV). However, the settling time becomes the longest among the three settings.
1	Normal	This setting has features between Slow and Fast.
2	Fast	Set this value when hastening the response to the change of the set value (SV). However, the overshoot and undershoot become the largest among the three settings.

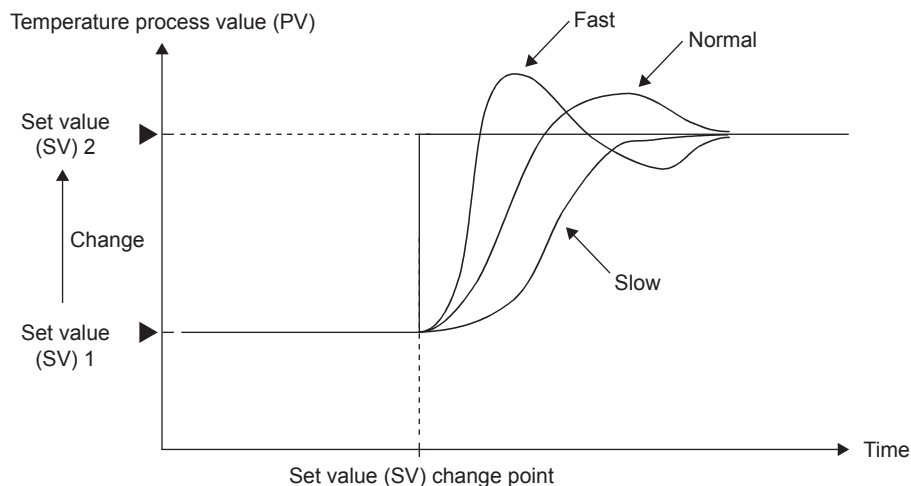

■ Default value

The default value is Slow (0).

CH1 Temperature rise completion range setting

Set the width of the temperature rise completion range. When the temperature process value (PV) satisfies the following conditions, the temperature rise is completed.

- $\text{Set value (SV)} - \text{Temperature rise completion range} \leq \text{Temperature process value (PV)} \leq \text{Set value (SV)} + \text{Temperature rise completion range}$

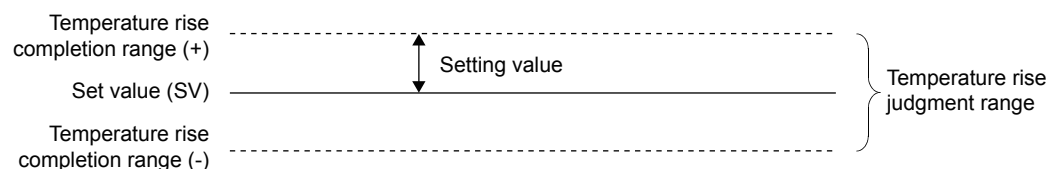

When the value set in 'CH1 Temperature process value (PV)' (UnG402) is within the temperature rise judgment range, 'CH1 Temperature rise judgment flag' (UnG404) is set to Within temperature rise completion range (ON). (For the time taken for 'CH1 Temperature rise judgment flag' (UnG404) to set to Within temperature rise completion range (ON) after the temperature rise completion, set the time in 'CH1 Temperature rise completion soak time setting' (UnG507).)

■Buffer memory address

The following table shows the buffer memory address of this area.

Buffer memory name	CH1	CH2	CH3	CH4
CH□ Temperature rise completion range setting	506	706	906	1106
Temperature rise completion range setting (If using FX3 allocation mode)	236			

■Setting range

1 to 100 (°C/°F or digit)

■Default value

The default value is 10.

CH1 Temperature rise completion soak time setting

Set the time taken to set 'CH1 Temperature rise judgment flag' (Un\G404) to Within temperature rise completion range (ON) after the completion of the temperature rise.

■Buffer memory address

The following table shows the buffer memory address of this area.

Buffer memory name	CH1	CH2	CH3	CH4
CH□ Temperature rise completion soak time setting	507	707	907	1107
Temperature rise completion soak time setting (If using FX3 allocation mode)	237			

■Setting range

The setting range is 0 to 3600 (s).

■Default value

The default value is 0 (s).

CH1 Upper limit output limiter

Set the upper limit value for actually outputting the manipulated value (MV) calculated by the standard PID operation to an external device.

■Buffer memory address

The following table shows the buffer memory address of this area.

Buffer memory name	CH1	CH2	CH3	CH4
CH□ Upper limit output limiter	508	708	908	1108
CH□ Upper limit output limiter (If using FX3 allocation mode)	64	104	144	184

■Setting range

The lower limit output limiter +1 to 1050 (105.0% max.).

Set values so that the lower limit output limiter value is smaller than the upper limit output limiter value.

When the lower limit output limiter value is equal to or greater than the upper limit output limiter value, CH□ Upper/lower limit output limiter setting error (error code: 1A0□H) occurs.

When a value out of the setting value is set, an out of setting range error (error code: 1950H) occurs. When an error has occurred, the following operations will be executed.

- 'Error flag' (Un\G398, b2) turns ON.
- An error code is stored in 'Latest error code' (Un\G0).

■Two-position control

In the two-position control, this setting is disabled.

■Default value

The default value is 1000 (100.0%).

CH1 Heating upper limit output limiter

Set the upper limit value for actually outputting the manipulated value for heating (MVh) calculated by the heating and cooling PID operation to an external device. In the auto tuning, this setting is ignored.

■Buffer memory address

The following table shows the buffer memory address of this area.

Buffer memory name	CH1	CH2	CH3	CH4
CH□ Heating upper limit output limiter	508	708	908	1108
CH□ Heating upper limit output limiter (If using FX3 allocation mode)	42	74	106	138

■Setting range

This is 0 to 1050 (0.0 to 105.0%).

When a value out of the setting value is set, an out of setting range error (error code: 1950H) occurs. When an error has occurred, the following operations will be executed.

- 'Error flag' (Un\G398, b2) turns ON.
- An error code is stored in 'Latest error code' (Un\G0).

Point

In the heating-cooling PID control, the lower limit value is not used. When 'CH1 Lower limit output limiter' (Un\G509) is set to a value other than 0, an out of setting range error (error code: 1950H) occurs.

■Two-position control

In the two-position control, this setting is disabled.

■Default value

The default value is 1000 (100.0%).

CH1 Lower limit output limiter

Set the lower limit value for actually outputting the manipulated value (MV) calculated by the PID operation to an external device.

■Buffer memory address

The following table shows the buffer memory address of this area.

Buffer memory name	CH1	CH2	CH3	CH4
CH□ Lower limit output limiter	509	709	909	1109
CH□ Lower limit output limiter (If using FX3 allocation mode)	65	105	145	185

■Setting range

-50 to upper limit output limiter -1 (-5.0% min.)

Set values so that the lower limit output limiter value is smaller than the upper limit output limiter value.

When the lower limit output limiter value is equal to or greater than the upper limit output limiter value, CH□ Upper/lower limit output limiter setting error (error code: 1A0□H) occurs.

When a value out of the setting value is set, an out of setting range error (error code: 1950H) occurs. When an error has occurred, the following operations will be executed.

- 'Error flag' (Un\G398, b2) turns ON.
- An error code is stored in 'Latest error code' (Un\G0).

■Two-position control

In the two-position control, this setting is disabled.

■Default value

The default value is 0 (0.0%).

CH1 Output change ratio limiter

Set the limit of the output variation amount per 1s to regulate a rapid change of the manipulated value (MV).

■Buffer memory address

The following table shows the buffer memory address of this area.

Buffer memory name	CH1	CH2	CH3	CH4
CH□ Output change ratio limiter	510	710	910	1110
CH□ Output change ratio limiter (If using FX3 allocation mode)	67	107	147	187

■Setting range

The setting range is 0 or 1 to 1000 (0.1 to 100.0%/s). When 0 is set, the output variation amount is not regulated.

Ex.

When the following values have been set in the buffer memory areas

When 'CH1 Output change ratio limiter' (Un\G510) has been set to 10 (1.0%/s) and the sampling period is 500ms, an output value changes by 0.5% per 500ms. When the sampling period is 250ms, an output value changes by 0.2% or 0.3% per 250ms. Thus, even though the manipulated value (MV) rapidly changes by 50%, the variation amount is regulated to 1%/s. Thus, even though the manipulated value (MV) rapidly changes by 50%, the variation amount is regulated to 1%/s.

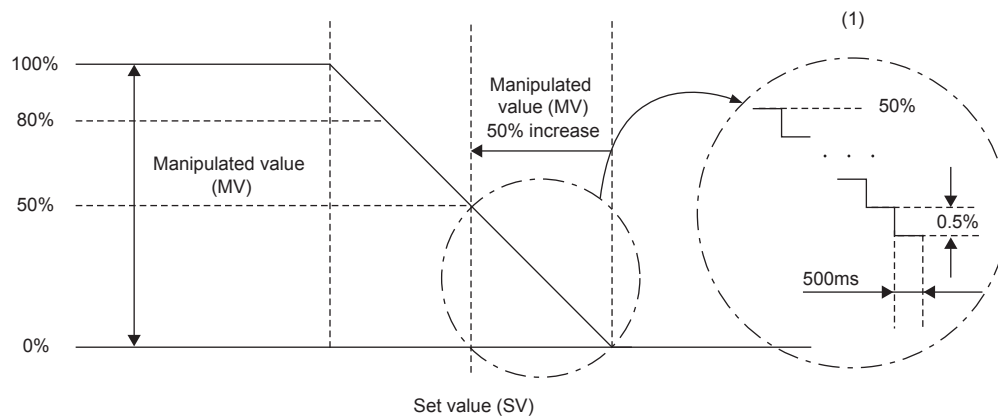

(1) When 'CH1 Output change ratio limiter' (Un\G510) has been set to 10 (1.0%/s)

■Two-position control

The setting is ignored.

■Manual control

The setting is enabled.

■At the execution of the auto tuning

The setting is enabled. However, when the output change ratio limiter setting is changed during the auto tuning, appropriate PID constants may not be calculated. Therefore, adjusting the output variation amount during the auto tuning is not recommended.

■Default value

The default value is 0.

CH1 Upper limit setting limiter

Set the upper limit value of the set value (SV).

■Buffer memory address

The following table shows the buffer memory address of this area.

Buffer memory name	CH1	CH2	CH3	CH4
CH□ Upper limit setting limiter	511	711	911	1111
CH□ Upper limit setting limiter (If using FX3 allocation mode)	76	116	156	196

■Setting range

The settings range depends on the type of inputs used.

- Internal temperature inputs: Lower limit setting limiter +1 to input range upper limit
- Internal micro voltage inputs: Lower limit setting limiter +1 to scaling range upper limit
- External inputs: Lower limit setting limiter +1 to external input range upper limit

Configure the settings that satisfy the following conditions.

- 'CH1 Lower limit setting limiter' (Un\G512) < 'CH1 Upper limit setting limiter' (Un\G511)

When the above conditions are not satisfied, CH□ Upper/lower limit setting limiter error (error code: 1A1□H) occurs.

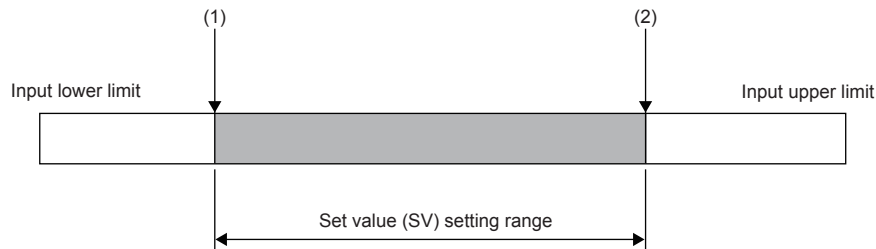

(1) 'CH1 Lower limit setting limiter' (Un\G512)

(2) 'CH1 Upper limit setting limiter' (Un\G511)

■Setting unit

The value to be set differs depending on the value stored in 'CH1 Decimal point position' (Un\G400). (Page 128 CH1 Decimal point position)

- No decimal point (0): Set a value in increments of 1°C (or digit).
- If there is 1 digit (1) past the decimal point: Set a value (the value multiplied by 10) in increments of 0.1°C (°F).

■Default value

The default value is 1300.

CH1 Lower limit setting limiter

Set the lower limit value of the set value (SV).

■Buffer memory address

The following table shows the buffer memory address of this area.

Buffer memory name	CH1	CH2	CH3	CH4
CH□ Lower limit setting limiter	512	712	912	1112
CH□ Lower limit setting limiter (If using FX3 allocation mode)	77	117	157	197

■Setting range

The settings range depends on the type of inputs used.

- Internal temperature inputs: Input range lower limit to upper limit setting limiter -1
- Internal low voltage: Scaling range lower limit to upper limit setting limiter -1
- External inputs: External input range lower limit to upper limit setting limiter -1

■Setting unit

For the setting unit, refer to the following.

☞ Page 147 Setting unit

■Default value

The default value is -100.

CH1 Setting change rate limiter

Sets the set value (SV) change rate per minute when changing the set value (SV). This setting can regulate a rapid change of the manipulated value (MV).

■Buffer memory address

The following table shows the buffer memory address of this area.

Buffer memory name	CH1	CH2	CH3	CH4
CH□ Setting change rate limiter	513	713	913	1113
CH□ Setting change rate limiter (If using FX3 allocation mode)	73	113	153	193

■Setting range

0 to 1000 (span^{*1} 0.1 to 100.0%). When 0 is set, this setting is disabled.

*1 During internal temperature inputs, input range span. During internal micro voltage inputs, scaling span. During external inputs, external input span.

■Default value

Set to disabled (0).

CH1 Normal/Reverse operation setting

Select whether to use CH1 with normal operations or reverse operations.

Select normal operations for the cooling control. Select reverse operations for the heating control.

For details on the normal/reverse operation selection function, refer to the following.

☞ Page 32 Normal/Reverse Operation Selection Function

■Buffer memory address

The following table shows the buffer memory address of this area.

Buffer memory name	CH1	CH2	CH3	CH4
CH□ Normal Reverse Operation setting	515	715	915	1115
CH□ Normal Reverse Operation setting (If using FX3 allocation mode)	75	115	155	195

■Setting range

- 0: Normal Operation
- 1: Reverse Operation

■Default value

The default value is Reverse Operation (1).

CH1 Adjustment sensitivity (dead band) setting

To prevent chattering of the manipulated value (MV) in the two-position control, set the adjustment sensitivity (dead band) for the set value (SV).

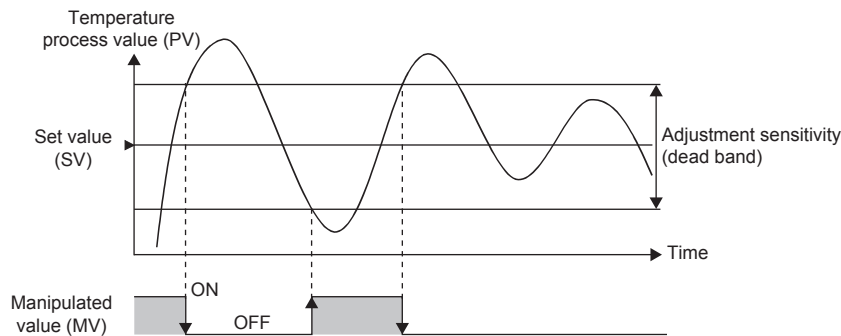

For details on the two-position control, refer to the following.

☞ Page 26 Control Method

■Buffer memory address

The following table shows the buffer memory address of this area.

Buffer memory name	CH1	CH2	CH3	CH4
CH□ Adjustment sensitivity (dead band) setting	516	716	916	1116
CH□ Adjustment sensitivity (dead band) setting (If using FX3 allocation mode)	69	109	149	189

■Setting range

Set a value within the range of 1 to 100^{*1} (Span 0.1 to 10.0%).

*1 During internal temperature inputs, input range span. During internal micro voltage inputs, scaling span. During external inputs, external input span.

Ex.

When the following values have been set in the buffer memory areas

- 'CH1 Input range' (Un\G501): 19 (Temperature measuring range: -200.0°C to +400.0°C)
- 'CH1 Adjustment sensitivity (dead band) setting' (Un\G516): 10 (1.0%)

(Span) × (Adjustment sensitivity (dead band) setting) = (400.0°C - (-200.0°C)) × 0.01 = 6.0°C

The dead band is the set value (SV) ±3.0°C.

■Default value

The default value is 10 (1.0%).

CH1 AUTO/MAN mode shift

Select the value calculated by a PID operation as the manipulated value (MV) or set the manipulated value (MV) manually.

■Buffer memory address

The following table shows the buffer memory address of this area.

Buffer memory name	CH1	CH2	CH3	CH4
CH□ AUTO/MAN mode shift	518	718	918	1118
CH□ AUTO/MAN mode shift (If using FX3 allocation mode)	54	94	134	174

■Setting range

Setting value	Setting detail	Description
0	AUTO	The AUTO (automatic) mode is activated. The process value (PV) or external input value and the set value (SV) are compared, and a PID calculation implemented.
1	MAN	The MAN (manual) mode is activated. Fix to the value set using "CH1 Manual outputs setting" (Un\G519).

■Default value

The default value is AUTO (0).

CH1 Manual output setting

This buffer memory area is used to set the manipulated value (MV) in the MAN mode.

Even though writing of data is executed during control in the AUTO mode, the setting values do not change.

■Buffer memory address

The following table shows the buffer memory address of this area.

Buffer memory name	CH1	CH2	CH3	CH4
CH□ Manual output setting	519	719	919	1119
CH□ Manual output setting (If using FX3 allocation mode)	55	95	135	175

■How to shift the mode

Change the mode with the following buffer memory area.

- 'CH1 AUTO/MAN mode shift' (Un\G518) ( Page 149 CH1 AUTO/MAN mode shift)

■Setting range

-50 to 1050 (-5.0 to 105.0%)

■Enabling the settings

Check that "CH1 event (Un\G429)" in the Manual output settings is b13 before writing.

A value that has been written while MAN mode shift completion flag is OFF will be replaced with the manipulated value (MV) that the system calculated using the PID operation.

■Default value

The default value is -50 (-5.0%).

CH1 Cooling upper limit output limiter

Set the upper limit value for actually outputting the manipulated value for cooling (MVc) calculated by the cooling and heating PID operation to an external device. In the auto tuning, this setting is ignored.

■Buffer memory address

The following table shows the buffer memory address of this area.

Buffer memory name	CH1	CH2	CH3	CH4
CH□ Cooling upper limit output limiter	521	721	921	1121
CH□ Cooling upper limit output limiter (If using FX3 allocation mode)	66	106	146	186

■Setting range

This is 0 to 1050 (0.0 to 105.0%).

Point

In the heating-cooling PID control, the lower limit value is not used. When 'CH1 Lower limit output limiter' (Un\G509) is set to a value other than 0, an out of setting range error (error code: 1950H) occurs.

■Two-position control

In the two-position control, this setting is disabled.

■Default value

The default value is 1000 (100.0%).

CH1 Cooling control output cycle setting

Sets the cooling control output cycle (time proportional cycle).

Cooling manipulated value (MVc) ON time and OFF time are each as described below.

- ON time: Cooling control output cycle (s) × cooling manipulated value (%)
- OFF time: Cooling control output cycle (s) × (100 - cooling manipulated value (%))

For details, refer to  Page 142 CH1 Control output cycle setting.

■Buffer memory address

The following table shows the buffer memory address of this area.

Buffer memory name	CH1	CH2	CH3	CH4
CH□ Cooling control output cycle setting	522	722	922	1122
CH□ Cooling control output cycle setting (If using FX3 allocation mode)	71	111	151	191

CH1 Cooling method setting

Set a cooling control method in the heating-cooling PID control. Select a cooling method suitable for cooling characteristics of devices.

For details on the cooling method setting function, refer to the following.

 Page 35 Cooling Method Setting Function

■Buffer memory address

The following table shows the buffer memory address of this area.

Buffer memory name	CH1	CH2	CH3	CH4
CH□ Cooling method setting	523	723	923	1123
CH□ Cooling method setting (If using FX3 allocation mode)	232			

■Setting range

- 0: Air cooling
- 1: Water cooling
- 2: Cooling gain linear

Point

PID constant calculation results are effected by AT (auto tuning) depending on the settings, so set before implementing AT (auto tuning).

■Default value

The default value is 0 (air cooling).

CH1 Overlap/dead band setting

Configure the overlap/dead band setting. For details on the overlap/dead band function, refer to the following.

 Page 34 Overlap/dead Band Function

■Buffer memory address

The following table shows the buffer memory address of this area.

Buffer memory name	CH1	CH2	CH3	CH4
CH□ Overlap/dead band setting	524	724	924	1124
CH□ Overlap/dead band setting (If using FX3 allocation mode)	63	103	143	183

■Setting range

Setting value	Description
-100 to -1 (span ^{*1} -10.0 to -0.1%)	Overlap
0	None
1 to 100 (span ^{*1} 0.1 to 10.0%)	Dead band

*1 During internal temperature inputs, input range span. During internal micro voltage inputs, scaling span. During external inputs, external input span.

■Default value

The default value is 0 (None).

CH1 Alert dead band setting

This setting is uses the alert function. This is the common setting for all channel alerts 1 to 4.

For details of the alert function, refer to the following.

 Page 54 Alert Function

■Buffer memory address

The following table shows the buffer memory address of this area.

Buffer memory name	CH1	CH2	CH3	CH4
CH□ Alert dead band setting	531	731	931	1131
Alert dead band setting (If using FX3 allocation mode)	233			

■Setting range

0 to 100 (span^{*1} 0.0 to 10.0%)

*1 During internal temperature inputs, input range span. During internal micro voltage inputs, scaling span. During external inputs, external input span

■Default value

Set to 10 (1.0% of span).

CH1 Number of alert delay

Set the number of times to execute sampling to judge an alert. This is the common setting for all channel alerts 1 to 4. By setting the number of times to execute sampling, when the temperature process value (PV) stays within the alert range after the temperature process value (PV) has entered the alert range until the number of times to execute sampling exceeds the number of alert delay, an alert occurs. For details of the alert function, refer to the following.

 Page 54 Alert Function

■Buffer memory address

The following table shows the buffer memory address of this area.

Buffer memory name	CH1	CH2	CH3	CH4
CH□ Number of alert delay	532	732	932	1132
Number of alert delay (If using FX3 allocation mode)	234			

■Setting range

The setting range is 0 to 30000 (times).

Point

When 0 (times) has been set, an alert occurs as soon as the temperature process value (PV) goes within the alert range.

■Default value

The default value is 0 (times).

CH1 Alert 1 mode setting

Set the alert mode of Alert 1. For details of the alert function, refer to the following.

 Page 54 Alert Function

■Buffer memory address

The following table shows the buffer memory address of this area.

Buffer memory name	CH1	CH2	CH3	CH4
CH□ Alert 1 mode setting	533	733	933	1133
CH□ Alert 1 mode setting (If using FX3 allocation mode)	209	215	221	227

■Alert mode and alert set value

Set an alert set value for the alert mode of Alert 1 selected in this setting. Set a value in 'CH1 Alert set value 1' (Un\G434). 'CH1 Alert set value 1' (Un\G434) corresponds to the alert mode of Alert 1.

■Setting range

The following table lists setting values and setting ranges of alert set values in each alert mode.

Setting value	Alert mode	Setting range of alert set value
0	No alert (Alert not implemented)	—
1	Upper limit input alert	Value within set input range ^{*1}
2	Lower limit input alert	
3	Upper limit deviation alert	- span to + span ^{*2}
4	Lower limit deviation alert	
5	Upper/lower limit deviation alert	0 to + span ^{*2}
6	Within-range alert	
7	Upper limit input alert with wait	Value within set input range ^{*1}
8	Lower limit input alert with wait	
9	Upper limit deviation alert with wait	- span to + span ^{*2}
10	Lower limit deviation alert with wait	
11	Upper/lower limit deviation alert with wait	0 to + span ^{*2}
12	Upper limit deviation alert with re-wait	
13	Lower limit deviation alert with re-wait	- span to + span ^{*2}
14	Upper/lower limit deviation alert with re-wait	

*1 During internal temperature inputs, input range. During internal micro voltage inputs, scaling range. During external inputs, external input range.

*2 During internal temperature inputs, input range span. During internal micro voltage inputs, scaling span. During external inputs, external input span.

■Enabling the settings

If changing the settings, turn OFF→ON→OFF the 'Settings change command' (Un\G399, b11) in normal mode to enable the settings contents.

■Default value

The default value is 0.

CH1 Alert 2 mode setting

Set the alert mode of Alert 2. For details of the alert function, refer to the following.

☞ Page 54 Alert Function

■Buffer memory address

The following table shows the buffer memory address of this area.

Buffer memory name	CH1	CH2	CH3	CH4
CH□ Alert 2 mode setting	534	734	934	1134
CH□ Alert 2 mode setting (If using FX3 allocation mode)	210	216	222	228

■Alert mode and alert set value

Set an alert set value for the alert mode of Alert 2 selected in this setting. Set a value in 'CH1 Alert set value 2' (Un\G435). 'CH1 Alert set value 2' (Un\G435) corresponds to the alert mode of Alert 2.

■Setting range

For the setting range, refer to the following in CH1 Alert 1 mode setting.

☞ Page 154 Setting range

■Enabling the settings

For enabling the settings, refer to the following in CH1 Alert 1 mode setting.

☞ Page 154 Enabling the settings

■Default value

For the default value, refer to the following in CH1 Alert 1 mode setting.

☞ Page 154 Default value

CH1 Alert 3 mode setting

Set the alert mode of Alert 3. For details of the alert function, refer to the following.

☞ Page 54 Alert Function

■Buffer memory address

The following table shows the buffer memory address of this area.

Buffer memory name	CH1	CH2	CH3	CH4
CH□ Alert 3 mode setting	535	735	935	1135
CH□ Alert 3 mode setting (If using FX3 allocation mode)	211	217	223	229

■Alert mode and alert set value

Set an alert set value for the alert mode of Alert 3 selected in this setting. Set a value in 'CH1 Alert set value 3' (Un\G436). 'CH1 Alert set value 3' (Un\G436) corresponds to the alert mode of Alert 3.

■Setting range

For the setting range, refer to the following in CH1 Alert 1 mode setting.

☞ Page 154 Setting range

■Enabling the settings

For enabling the settings, refer to the following in CH1 Alert 1 mode setting.

☞ Page 154 Enabling the settings

■Default value

For the default value, refer to the following in CH1 Alert 1 mode setting.

☞ Page 154 Default value

CH1 Alert 4 mode setting

Set the alert mode of Alert 4. For details of the alert function, refer to the following.

☞ Page 54 Alert Function

■Buffer memory address

The following table shows the buffer memory address of this area.

Buffer memory name	CH1	CH2	CH3	CH4
CH□ Alert 4 mode setting	536	736	936	1136
CH□ Alert 4 mode setting (If using FX3 allocation mode)	212	218	224	230

■Alert mode and alert set value

Set an alert set value for the alert mode of Alert 4 selected in this setting. Set a value in 'CH1 Alert set value 4' (Un\G437). 'CH1 Alert set value 4' (Un\G437) corresponds to the alert mode of Alert 4.

■Setting range

For the setting range, refer to the following in CH1 Alert 1 mode setting.

☞ Page 154 Setting range

■Enabling the settings

For enabling the settings, refer to the following in CH1 Alert 1 mode setting.

☞ Page 154 Enabling the settings

■Default value

For the default value, refer to the following in CH1 Alert 1 mode setting.

☞ Page 154 Default value

CH1 Loop disconnection detection judgment time

Set the loop disconnection detection judgment time constant.

For loop disconnections, the amount of change to the process value (PV) is detected for each loop disconnection detection judgment time from when the manipulated value (MV) is either 100% (or the upper limit output limiter) or greater, or 0% (or the lower limit output limiter) or lower, and the loop disconnection alert turns ON when it is judged that a control loop error has occurred. For details of the loop disconnection detection function, refer to the following.

☞ Page 61 Loop Disconnection Detection Function

■Buffer memory address

The following table shows the buffer memory address of this area.

Buffer memory name	CH1	CH2	CH3	CH4
CH□ Loop disconnection detection judgment time	537	737	937	1137
CH□ Loop disconnection detection judgment time (If using FX3 allocation mode)	78	118	158	198

■Setting range

The setting range is 0 to 7200 (s). Set to 0 to turn OFF this function.

■When executing the auto tuning

A value that is twice as large as the value in 'CH1 Integral time (I) setting' (Un\G432) is automatically set in this setting.

■Default value

The default value is 480 (s).

CH1 Loop disconnection detection dead band

Set the non-alert area having the set value (SV) at the center (temperature width in which no loop disconnection is detected) to prevent accidental alerts of the loop disconnection detection.

For details on the loop disconnection detection function, refer to the following.

☞ Page 61 Loop Disconnection Detection Function

■Buffer memory address

The following table shows the buffer memory address of this area.

Buffer memory name	CH1	CH2	CH3	CH4
CH□ Loop disconnection detection dead band	538	738	938	1138
CH□ Loop disconnection detection dead band (If using FX3 allocation mode)	79	119	159	199

■Setting range

0 to input span^{*1}

*1 During internal temperature inputs, input range span. During internal micro voltage inputs, scaling span. During external inputs, external input span.

■Setting unit

The value to be set differs depending on the value stored in 'CH1 Decimal point position' (Un\G400).

- No decimal point (0): Set a value in increments of 1°C (°F or digit).
- If there is 1 digit (1) past the decimal point: Set a value (the value multiplied by 10) in increments of 0.1°C (°F).

■Default value

The default value is 0.

CH1 AT bias

If the process value (PV) does not exceed the set value (SV) during auto tuning implementation, AT bias is set. For details of the AT (auto tuning) function, refer to the following.

☞ Page 40 AT (Auto Tuning) Bias Function

■ Buffer memory address

The following table shows the buffer memory address of this area.

Buffer memory name	CH1	CH2	CH3	CH4
CH□ AT bias	546	746	946	1146
CH□ AT bias (If using FX3 allocation mode)	74	114	154	194

■ Setting range

- span to + span^{*1} (If span exceeds 32767, the span becomes -322768 to +322767.)

*1 During internal temperature inputs, input range span. During internal micro voltage inputs, scaling span. During external inputs, external input span.

■ Setting unit

The value to be set differs depending on the value stored in 'CH1 Decimal point position' (Un\G400).

- No decimal point (0): Set a value in increments of 1°C (°F or digit).
- If there is 1 digit (1) past the decimal point: Set a value (the value multiplied by 10) in increments of 0.1°C (°F).

■ Default value

The default value is 0.

CH1 Startup tuning setting

Sets stop/implement startup tuning.

For details of the startup tuning function, refer to the following.

☞ Page 41 Startup Tuning Function

■ Buffer memory address

The following table shows the buffer memory address of this area.

Buffer memory name	CH1	CH2	CH3	CH4
CH□ Startup tuning setting	548	748	948	1148
CH□ Startup tuning setting (If using FX3 allocation mode)	87	127	167	207

■ Setting range

- 0: Stop startup tuning
- 1: Implement startup tuning

■ Default value

Set to 0 (Stop startup tuning).

Precautions

Auto tuning is implemented if control is started when both the 'auto tuning command' (Un\G399, b4) and 'startup tuning implementation command' (Un\G548) status is "1".

CH1 Primary delay digital filter setting

The temperature process value (PV) are smoothed and sudden changes are absorbed by using the primary delay digital filter.

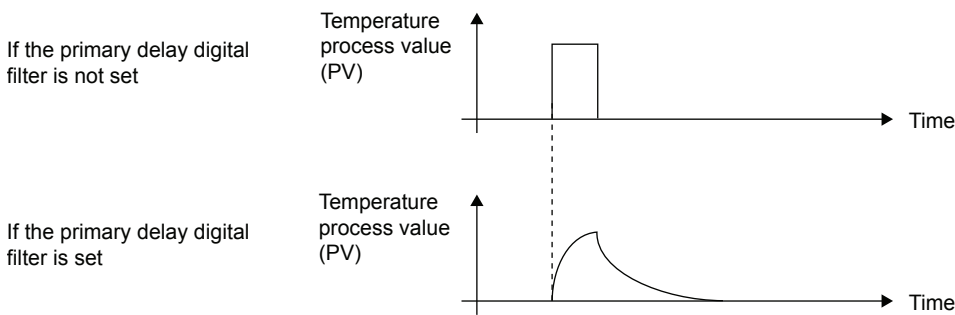

The time for the temperature process value (PV) to change by 63.3% can be set by the primary delay digital filter setting (filter setting time).

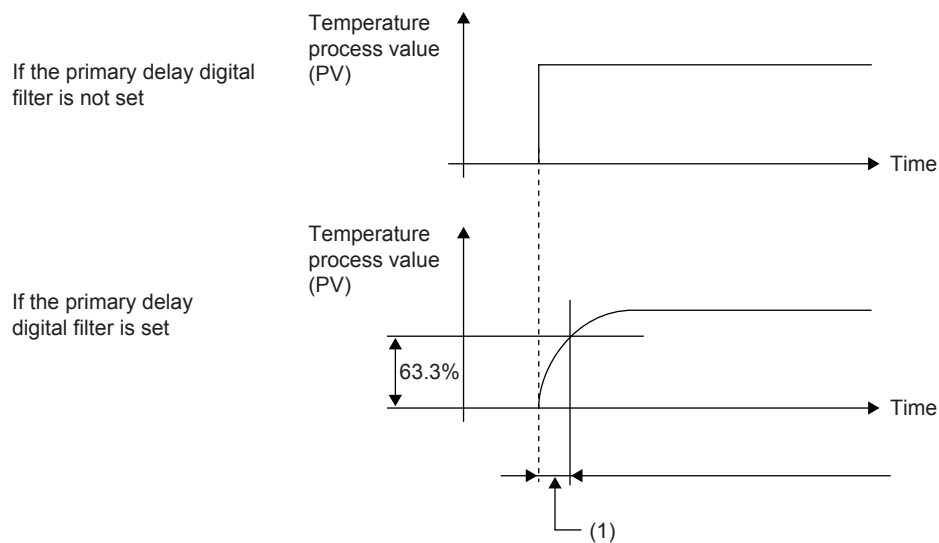

(1) 'CH1 Primary delay digital filter setting' (Un\G563)

■ Buffer memory address

The following table shows the buffer memory address of this area.

Buffer memory name	CH1	CH2	CH3	CH4
CH□ Primary delay digital filter setting	563	763	963	1163
CH□ Primary delay digital filter setting (If using FX3 allocation mode)	72	112	152	192

■ Setting range

0 or 1 to 100 (1 to 100s). When 0 is set, the primary delay digital filter processing is not implemented.

■ Default value

The default value is 0 (Disable).

CH1 Sensor correction value setting

Set the correction value used when there is an error between a process temperature and the actual temperature. For details on the sensor correction function, refer to the following.

☞ Page 48 Sensor Correction Function

■ Buffer memory address

The following table shows the buffer memory address of this area.

Buffer memory name	CH1	CH2	CH3	CH4
CH□ Sensor correction value setting	565	765	965	1165
CH□ Sensor correction value setting (If using FX3 allocation mode)	68	108	148	188

■ Setting range

-5000 to +5000 (span^{*1} -50.00 to +50.00%)

*1 During internal temperature inputs, input range span. During internal micro voltage inputs, scaling span. During external inputs, external input span.

Ex.

[Condition]

When the input range span is 400°C and correction by 2°C is required

- 'CH1 Input range' (Un\G501): 0 (Temperature measuring range: -200.0°C to +200.0°C)

[Sensor correction value]

- 'CH1 Sensor correction value setting' (Un\G565): 50 (0.5%)

(Span) × (Sensor correction value setting) = (200.0°C - (-200.0°C)) × 0.5 = 2.0°C

[Display value]

Displayed value = Process value (PV) + Sensor correction value

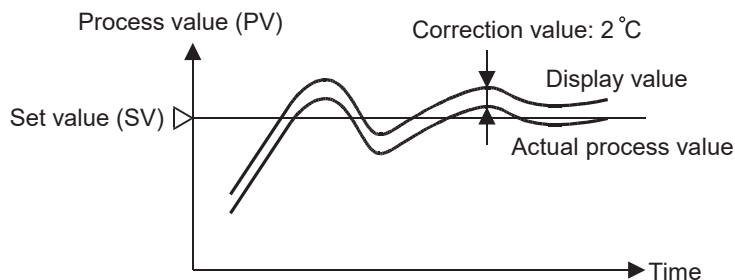

■ Setting unit

The value to be set differs depending on the value stored in 'CH1 Decimal point position' (Un\G400).

- No decimal point (0): Set a value in increments of 1°C (°F or digit).
- If there is 1 digit (1) past the decimal point: Set a value (the value multiplied by 10) in increments of 0.1°C (°F).

■ Default value

The default value is 0.

CH1 Operation mode setting

Set the operations mode.

- 0: Channel not used.
- 1: Process value (PV) monitoring only is implemented.
- 2: Process value (PV) monitoring + alert operations are implemented. (Alert operations are implemented when the settings and operations mode command (Un\G399, b1) is 1.)
- 3: Process value (PV) monitoring + alert operations + control are implemented. (Alert operations and control are implemented when the settings and operations mode command (Un\G399, b1) is 1.)

■Buffer memory address

The following table shows the buffer memory address of this area.

Buffer memory name	CH1	CH2	CH3	CH4
Operation mode setting	590	790	990	1190
Operation mode setting (If using FX3 allocation mode)	57	97	137	177

■Setting range

The setting range is 0 to 3.

■Default value

The default value is 3.

CH1 Micro voltage input scaling upper limit

Sets the display range upper limit during micro voltage inputs.

■Buffer memory address

The following table shows the buffer memory address of this area.

Buffer memory name	CH1	CH2	CH3	CH4
Micro voltage input scaling upper limit	591	791	991	1191
Micro voltage input scaling upper limit (If using FX3 allocation mode)	80	120	160	200

■Setting range

The setting range is -20000 to +20000.

However, set so that span (upper limit - lower limit absolute values) is 20000 max., and micro voltage input scaling upper limit is greater than micro voltage input scaling lower limit.

■Default value

Set to 10000 (digits).

CH1 Micro voltage input scaling lower limit

Sets the display range lower limit during micro voltage inputs.

■Buffer memory address

The following table shows the buffer memory address of this area.

Buffer memory name	CH1	CH2	CH3	CH4
Micro voltage input scaling lower limit	592	792	992	1192
Micro voltage input scaling lower limit (If using FX3 allocation mode)	81	121	161	201

■Setting range

The setting range is -20000 to +20000.

However, set so that span (upper limit - lower limit absolute values) is 20000 max., and micro voltage input scaling upper limit is greater than micro voltage input scaling lower limit.

■Default value

Set to 0 (digits).

CH1 External input range upper limit

Sets the upper limit of the external input values during external inputs.

■Buffer memory address

The following table shows the buffer memory address of this area.

Buffer memory name	CH1	CH2	CH3	CH4
External input range upper limit	593	793	993	1193
External input range upper limit (If using FX3 allocation mode)	82	122	162	202

■Setting range

The setting range is -32000 to +32000.

However, set so that external input range upper limit is greater than external input range lower limit.

■Default value

The default value is 10000.

CH1 External input range lower limit

Sets the lower limit of the external input values during external inputs.

■Buffer memory address

The following table shows the buffer memory address of this area.

Buffer memory name	CH1	CH2	CH3	CH4
External input range lower limit	594	794	994	1194
External input range lower limit (If using FX3 allocation mode)	83	123	163	203

■Setting range

The setting range is -32000 to +32000.

However, set so that external input range upper limit is greater than external input range lower limit.

■Default value

The default value is 0.

CH1 External output range upper limit

Sets the upper limit of the external output values during external outputs.

■Buffer memory address

The following table shows the buffer memory address of this area.

Buffer memory name	CH1	CH2	CH3	CH4
External output range upper limit	595	795	995	1195
External output range upper limit (If using FX3 allocation mode)	84	124	164	204

■Setting range

The setting range is -32000 to +32000.

However, set so that external output range upper limit is greater than external output range lower limit.

■Default value

The default value is 10000.

CH1 External output range lower limit

Sets the lower limit of the external output values during external outputs.

■Buffer memory address

The following table shows the buffer memory address of this area.

Buffer memory name	CH1	CH2	CH3	CH4
External output range lower limit	596	796	996	1196
External output range lower limit (If using FX3 allocation mode)	85	125	165	205

■Setting range

The setting range is -32000 to +32000.

However, set so that external output range upper limit is greater than external output range lower limit.

■Default value

The default value is 0.

CH1 Transistor output functions selection

Sets the transistor output functions.

■Buffer memory address

The following table shows the buffer memory address of this area.

Buffer memory name	CH1	CH2	CH3	CH4
External output range lower limit	597	797	997	1197
External output range lower limit (If using FX3 allocation mode)	86	126	166	206

■Setting range

The setting range is 0 to 7.

For details, refer to [Page 53 Transistor Outputs Selection Function](#).

■Enabling the settings

If changing the settings, turn OFF→ON→OFF the 'Settings change command' (Un\G399, b11) in normal mode to enable the settings contents.

■Default value

The default value is 0.

Heater disconnection/output OFF-time current error detection delay count

Set the limit value for consecutive heater disconnection detections and output off-time current error detections so that the number of errors exceeding the limit value triggers an alert judgment. This is the common setting for all channels.

For details on the heater disconnection detection function, refer to the following.

[Page 63 Heater Disconnection Detection Function](#)

For details on the output off-time current error detection function, refer to the following.

[Page 63 Output OFF-time Current Error Detection Function](#)

■Buffer memory address

The following table shows the buffer memory address of this area.

Buffer memory name	CH1	CH2	CH3	CH4
Heater disconnection/output OFF-time current error detection delay count	2000			
Heater disconnection/output OFF-time current error detection delay count (If using FX3 allocation mode)	235			

■Setting range

The setting range is 3 to 255 (times).

■Default value

The default value is 3 (times).

CT monitor method switching

Set the method for executing the heater current measurement. This is the common setting for all channels.

■Buffer memory address

The following table shows the buffer memory address of this area.

Buffer memory name	CH1	CH2	CH3	CH4
CT monitor method switching	2002			
CT monitor method switching (If using FX3 allocation mode)	238			

■Setting range

- 0: ON current/OFF current
- 1: ON current

When ON/OFF current (0) is set, the present current value of the current sensor (CT) is process.

When ON current (1) is set, the current value of the heater being OFF is fixed as the current value of the heater previously being ON.

■Default value

The default value is ON/OFF current (0).

CH1 Heater disconnection alert setting

Sets the value if a current error is detected when a disconnection is detected and outputs are OFF.

- A heater disconnection alert occurs if the heater current process value while control outputs are ON is below the heater disconnection alert settings. ('Event' (Un\G429) b9 turns ON.)
- A current error alert occurs when outputs are OFF if the heater current process value when control outputs are OFF is the heater disconnection setting or greater. ('Event' (Un\G429) b10 turns ON.)

For details on the heater disconnection detection function, refer to the following.

☞ Page 63 Heater Disconnection Detection Function

For details on the output off-time current error detection function, refer to the following.

☞ Page 63 Output OFF-time Current Error Detection Function

Precautions

If external outputs are selected using control mode switching, the heater disconnection alert function is disabled.

■Buffer memory address

The following table shows the buffer memory address of this area.

Buffer memory name	CH1	CH2	CH3	CH4
CH□ Heater disconnection alert setting	2004	2007	2010	2013
CH□ Heater disconnection alert setting (If using FX3 allocation mode)	53	93	133	173

■Setting range

0 to 1000 (0.0 to 100.0 A).

When 0 is set, heater disconnection detections and output off-time current error detections are not executed.

■Default value

The default value is 0 (A).

CH1 Heater current process value

Stores the heater current value detected by the temperature control module.

■Buffer memory address

The following table shows the buffer memory address of this area.

Buffer memory name	CH1	CH2	CH3	CH4
CH□ Heater current process value	2030	2031	2032	2033
CH□ Heater current process value (If using FX3 allocation mode)	21	22	23	24

Precautions

If control mode comprising external outputs using control mode switching is selected,^{*1} CT inputs are not processed. 0 is normally stored in the heater current process value.

- *1 If control mode is 2, 3, 6, 7, all channels are normally 0.
If control mode is 4 or 5, only channels 2 and 4 are normally 0.

CH1 CT ratio setting

Set the number of second-winding (turns) of the current sensor (CT) to be connected. This is the common setting for all channels if using FX3 allocation mode.

■Buffer memory address

The following table shows the buffer memory address of this area.

Buffer memory name	CH1	CH2	CH3	CH4
CH□ CT ratio setting	2062	2063	2064	2065
CH□ CT ratio setting (If using FX3 allocation mode)	239			

■Setting range

The setting range is 1 to 9999.

Set the value to satisfy the following.

(Max. process current value (effective value)^{*1} × 1.1 ÷ CT ratio setting (CT secondary winding count used)) ≤ 0.1377

*1 Max. process current value (effective value) ≤ 100 A

Ex.

If CT ratio setting is 800, and the max. process current value (effective value) is 100 A, the left hand side = 0.1375, and the conditions are satisfied, so measuring up to 100 A is possible.

- Current sensor (CT) reference examples

CT model name	CT ratio set value
CTL-6-P-H/CTL-6-S-H/CTL-6-P	800
CTL-12-S36-8/CTL-12L-8	800
CTL-12-S56-10/CTL-12-S36-10	1000

■Default value

The default value is 800.

Error history

Up to 16 errors that occurred in the module are recorded.

	b15	to	b8 b7	to	b0
Un\G3600	Error code				
Un\G3601	First 2 digits of date		Last 2 digits of date		
Un\G3602	Month		Day		
Un\G3603	Time		Minute		
Un\G3604	Second		Day of the week		
Un\G3605	Millisecond (upper)		Millisecond (lower)		
Un\G3606	System area				
:					
:					
Un\G3609					

Item	Stored contents	Storage example ^{*1}
First two digits of the year/last two digits of the year	Stored in BCD code.	2014H
Month/day		630H
Hour/minute		1234H
Second		56H
Day of the week	One of the following values is stored in BCD code. Sunday: 0, Monday: 1, Tuesday: 2, Wednesday: 3, Thursday: 4, Friday: 5, Saturday: 6	1H
Millisecond (upper)	Stored in BCD code.	7H
Millisecond (lower)		89H

*1 Value stored when an error occurs at 12:34:56.789 on Monday, June 30, 2014

■Buffer memory address

The following table shows the buffer memory address of this area.

Buffer memory name	CH1	CH2	CH3	CH4
Error history	3600 to 3759			
Error history (If using FX3 allocation mode)	3600 to 3759			

Alarm history

Up to 16 alarms that occurred in the module are recorded.

	b15	to	b8	b7	to	b0
Un\G3760	Alarm code					
Un\G3761	First 2 digits of date			Last 2 digits of date		
Un\G3762	Month			Day		
Un\G3763	Time			Minute		
Un\G3764	Second			Day of the week		
Un\G3765	Millisecond (upper)			Millisecond (lower)		
Un\G3766	System area					
⋮						
Un\G3769						

Item	Stored contents	Storage example* ¹
First two digits of the year/last two digits of the year	Stored in BCD code.	2014H
Month/day		630H
Hour/minute		1234H
Second		56H
Day of the week	One of the following values is stored in BCD code. Sunday: 0, Monday: 1, Tuesday: 2, Wednesday: 3, Thursday: 4, Friday: 5, Saturday: 6	1H
Millisecond (upper)	Stored in BCD code.	7H
Millisecond (lower)		89H

*¹ Value stored when an alarm occurs at 12:34:56.789 on Monday, June 30, 2014

■ Buffer memory address

The following table shows the buffer memory address of this area.

Buffer memory name	CH1	CH2	CH3	CH4
Alarm history	3760 to 3919			
Alarm history (If using FX3 allocation mode)	3760 to 3919			

A

Appendix 5 PID

This section describes PID.

PID operations

The temperature control module can implement the process-value inexact differential PID control.

Operation method and operational expression

The process-value inexact differential PID control is an operation method in which a primary delay filter has been put on the input of a derivative action and high-frequency noise has been eliminated to execute PID operations on the deviation (E).

Algorithm of the process-value inexact differential PID control

The following figure shows the algorithm of the process-value inexact differential PID control.

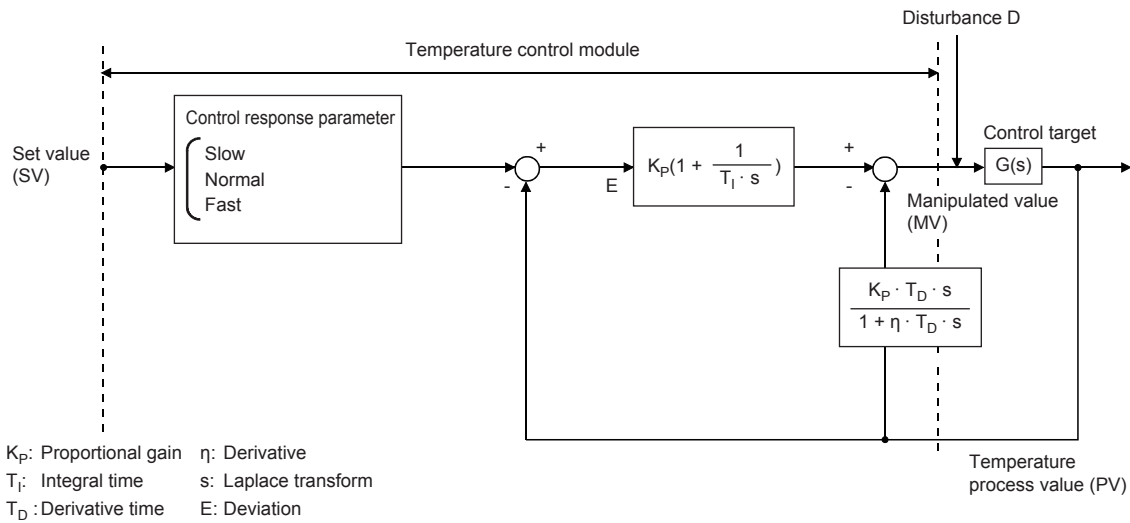

Operational expression

The following figure shows the operational expression of the temperature control module.

$$MV_n = K_p \left\{ E_n + \left(\frac{\tau}{T_i} E_n + I_{n-1} \right) + \left(\frac{\eta T_D}{\tau + \eta T_D} D_{n-1} - \frac{T_D}{\tau + \eta T_D} (PV_n - PV_{n-1}) \right) \right\}$$

- E: Deviation (SV-PV)
- τ : Sampling cycle
- MV: PID control in process-value incomplete derivation output
- PV: Process value
- K_p : Proportional gain
- T_i : Integral time
- T_D : Derivative time
- η : Derivative
- I: Integral value
- D: Derivative value

Point

The PID control in process-value derivation is an operation method in which the temperature process value (PV) is used as a derivative term in a PID operation. No deviation is used for the derivative term, drastic output changes due to a derivative action can be reduced when the deviation varies along with a set value change.

Actions of the temperature control module

The temperature control module implements PID operations with normal operation and reverse operation.

Normal Operation

In a normal operation, the manipulated value (MV) increases when the temperature process value (PV) is larger than the set value (SV). A normal operation is used for cooling control.

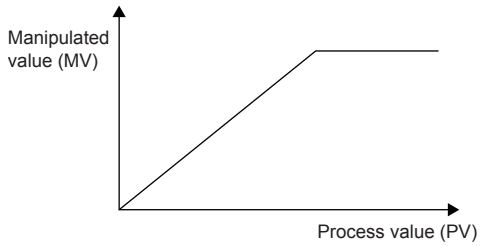

Reverse Operation

In a reverse operation, the manipulated value (MV) increases when the temperature process value (PV) is smaller than the set value (SV). A Reverse Operation is used for heating control.

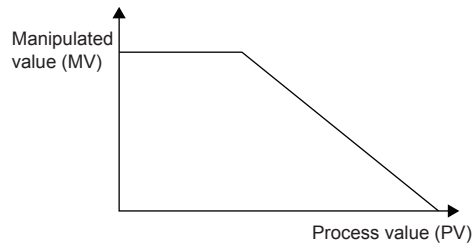

Proportional action (P action)

A proportional action is used to obtain the manipulated value (MV) proportional to the deviation (difference between the set value (SV) and the temperature process value (PV)).

Proportional gain

In a proportional action, the relation between changes in the deviation (E) and the manipulated value (MV) can be expressed using the following formula:

$$MV = K_P \cdot E$$

K_P is a proportional constant and is called proportional gain. The manipulated value (MV) varies within the range of -5.0% to 105.0%.

The following shows the difference of the actions depending on the proportional gain K_P .

Condition	Proportional action
When the proportional gain K_P is small	A control action slows down.
When the proportional gain K_P is large	The control action accelerates, but the temperature process value (PV) tends to fluctuate around the set value.

The following figure shows a proportional action of step responses of when the deviation (E) is a fixed value.

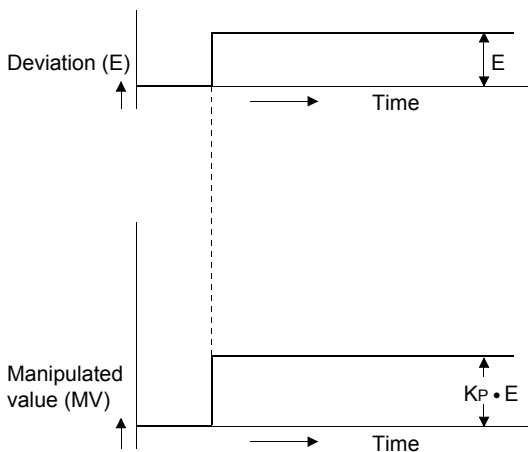

Offset

The certain amount of an error between the temperature process value (PV) and the set value (SV) is called an offset (remaining deviation). In a proportional action, an offset (remaining deviation) is generated.

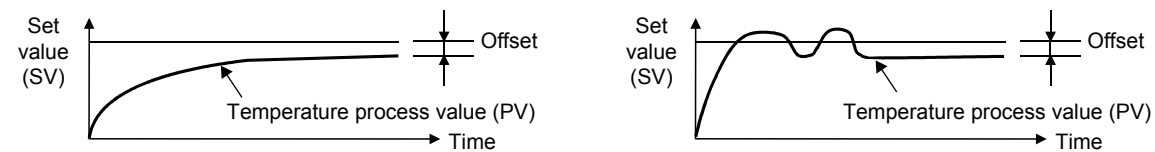

Integral action (I action)

An integral action that continuously changes the manipulated value (MV) to eliminate the deviation (E) when there is any. The offset caused by a proportional action can be eliminated.

In an integral action, the time taken for the manipulated value (MV) of the integral action after the generation of the deviation (E) to become the manipulated value (MV) of a proportional action is called integral time and expressed as T_I . The following shows the difference of the actions depending on the integral time T_I .

Condition	Integral action
When the integral time T_I is short	The integral effect becomes large and the time to eliminate the offset becomes short. However, the temperature process value (PV) tends to fluctuate around the set value.
When the integral time T_I is long	The integral effect becomes small and the time to eliminate the offset becomes long.

The following figure shows an integral action of step responses of when the deviation (E) is a fixed value.

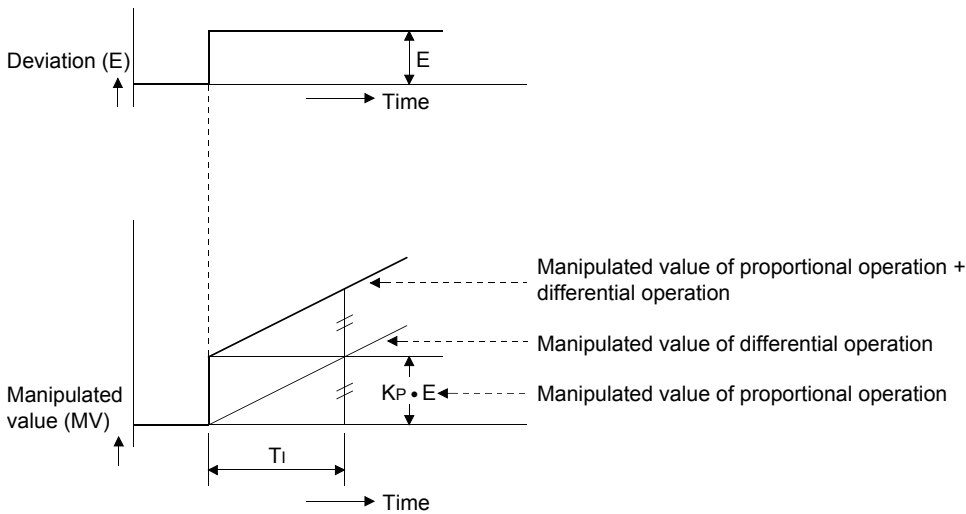

An integral action is used as a PI action in combination with a proportional action, or a PID action in combination with a proportional action and a derivative action. An integral action cannot be used by itself.



Derivative action (D action)

A derivative action adds the manipulated value (MV) proportional to the variation rate to eliminate the deviation (E) when it occurs. A derivative action can prevent the control target from changing significantly due to noise.

In a derivative action, the time taken for the manipulated value (MV) of the derivative action after the generation of the deviation (E) to become the value obtained by multiplying $\frac{1}{\eta} \times e^{-\frac{1}{\eta}}$ by the manipulated value (MV) of a proportional action is called derivative time and expressed as T_D .

Condition	Derivative action
When the derivative time T_D is short	The derivative effect becomes small.
When the derivative time T_D is long	The derivative effect becomes large. However, the temperature process value (PV) tends to fluctuate around the set value in short cycles.

The following figure shows a derivative of step responses of when the deviation (E) is a fixed value.

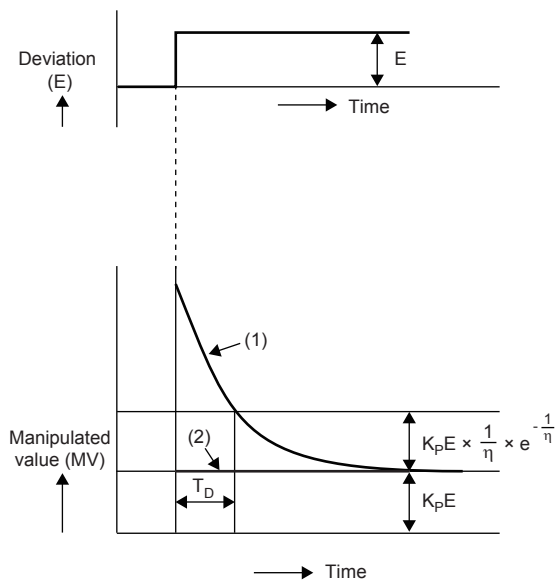

- (1) Manipulated value (MV) in a derivative operation
- (2) Manipulated value (MV) in a proportional operation

A derivative action is used as a PD action in combination with a proportional action, or PID action in combination with a proportional action and an integral action. A derivative action cannot be used by itself.

PID action

A PID action implements control using the manipulated value (MV) calculated by adding the proportional action, integral action, and derivative action. The following figure shows a PID action of step responses of when the deviation (E) is a fixed value.

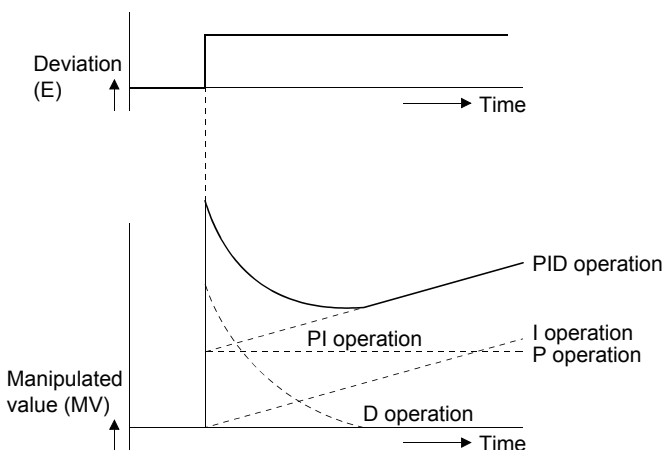

INDEX

A

Alarm history	165
Alert with re-wait	58
Alert with wait	57
Automatic setting at input range change	120
Automatic setting monitor at input range change	119

C

Cascade bias	122
Cascade gain	122
Cascade monitor	122
Cascade ON/OFF	121
CH1 Adjustment sensitivity (dead band) setting	149
CH1 Alert 1 mode setting	153
CH1 Alert 2 mode setting	154
CH1 Alert 3 mode setting	155
CH1 Alert 4 mode setting	155
CH1 Alert dead band setting	152
CH1 Alert definition	128
CH1 Alert set value 1	137
CH1 Alert set value 2	138
CH1 Alert set value 3	139
CH1 Alert set value 4	139
CH1 AT bias	157
CH1 AUTO/MAN mode shift	149
CH1 Control output cycle setting	142
CH1 Control response parameter	143
CH1 Cooling control output cycle setting	151
CH1 Cooling method setting	151
CH1 Cooling proportional band (Pc) setting	140
CH1 Cooling transistor output flag	133
CH1 Cooling upper limit output limiter	150
CH1 CT ratio setting	163
CH1 Decimal point position	128
CH1 Derivative time (D) setting	137
CH1 Event	134
CH1 External input range lower limit	161
CH1 External input range upper limit	160
CH1 External output range lower limit	161
CH1 External output range upper limit	161
CH1 Heater current process value	163
CH1 Heater disconnection alert setting	163
CH1 Heating control output cycle setting	142
CH1 Heating proportional band (Ph) setting	136
CH1 Heating transistor output flag	131
CH1 Heating upper limit output limiter	145
CH1 Input range	140
CH1 Integral time (I) setting	136
CH1 Loop disconnection detection dead band	156
CH1 Loop disconnection detection judgment time	156
CH1 Lower limit output limiter	145
CH1 Lower limit setting limiter	147
CH1 Manipulated value (MV)	129
CH1 Manipulated value (MV) for output with another (external) analog module	132
CH1 Manipulated value for cooling (MVc)	133
CH1 Manipulated value for cooling (MVc) for output with another (external) analog module	133
CH1 Manipulated value for heating (MVh)	129

CH1 Manipulated value for heating (MVh) for output with another (external) analog module	132
CH1 Manual output setting	150
CH1 Micro voltage input scaling lower limit	160
CH1 Micro voltage input scaling upper limit	160
CH1 Normal/Reverse operation setting	148
CH1 Number of alert delay	153
CH1 Operation mode setting	159
CH1 Output change ratio limiter	146
CH1 Overlap/dead band setting	152
CH1 Primary delay digital filter setting	158
CH1 Proportional band (P) setting	135
CH1 Sensor correction value setting	159
CH1 Set value (SV) monitor	132
CH1 Set value (SV) setting	135
CH1 Setting change rate limiter	148
CH1 Startup tuning setting	157
CH1 Temperature process value (PV)	129
CH1 Temperature process value (PV) for input with another (external) analog module	140
CH1 Temperature rise completion range setting	143
CH1 Temperature rise completion soak time setting	144
CH1 Temperature rise judgment flag	130
CH1 Transistor output flag (Control output flag)	131
CH1 Transistor output functions selection	161
CH1 Upper limit output limiter	144
CH1 Upper limit setting limiter	147
Control mode selection	119
Control mode selection monitor	118
CT monitor method switching	162

D

Deviation alert	55
-----------------	----

E

Error history	164
Error occurrence address	117

F

Firmware version	118
Flag	123

H

Heater disconnection/output OFF-time current error detection delay count	162
Heating/cooling PID control	24

I

Input alert	54
Input signal	124

L

Latest address of alarm history	118
Latest address of error history	117
Latest alarm code	117
Latest error code	117
Lower limit deviation alert.	56

M

Module information	123
------------------------------	-----

O

Output signal	126
-------------------------	-----

P

P control	28
PD control	29
PI control	28
PID control	29

S

Standard PID control	24
SV tracking selection	121

T

Two-position control	26
--------------------------------	----

U

Upper limit deviation alert.	55
Upper/lower limit deviation alert	56

W

Within-range alert	57
------------------------------	----

MEMO

REVISIONS

Revision date	Revision	Description
April 2017	A	First Edition
March 2019	B	■Added or modified parts SAFETY PRECAUTIONS, RELEVANT MANUALS, TERMS, Section 4.34, Appendix 4, TRADEMARKS
October 2019	C	■Added models FX5UJ CPU module ■Added or modified parts RELEVANT MANUALS, TERMS, Section 2.1, 2.3, Chapter 3, Appendix 4
March 2020	D	■Added or modified parts Appendix 4, TRADEMARKS
June 2021	E	■Modified part SAFETY PRECAUTIONS

Japanese manual number: SH-081798-E

This manual confers no industrial property rights or any rights of any other kind, nor does it confer any patent licenses. Mitsubishi Electric Corporation cannot be held responsible for any problems involving industrial property rights which may occur as a result of using the contents noted in this manual.

© 2017 MITSUBISHI ELECTRIC CORPORATION

WARRANTY

Please confirm the following product warranty details before using this product.

1. Gratis Warranty Term and Gratis Warranty Range

If any faults or defects (hereinafter "Failure") found to be the responsibility of Mitsubishi occurs during use of the product within the gratis warranty term, the product shall be repaired at no cost via the sales representative or Mitsubishi Service Company. However, if repairs are required onsite at domestic or overseas location, expenses to send an engineer will be solely at the customer's discretion. Mitsubishi shall not be held responsible for any re-commissioning, maintenance, or testing on-site that involves replacement of the failed module.

[Gratis Warranty Term]

The gratis warranty term of the product shall be for one year after the date of purchase or delivery to a designated place. Note that after manufacture and shipment from Mitsubishi, the maximum distribution period shall be six (6) months, and the longest gratis warranty term after manufacturing shall be eighteen (18) months. The gratis warranty term of repair parts shall not exceed the gratis warranty term before repairs.

[Gratis Warranty Range]

- (1) The range shall be limited to normal use within the usage state, usage methods and usage environment, etc., which follow the conditions and precautions, etc., given in the instruction manual, user's manual and caution labels on the product.
- (2) Even within the gratis warranty term, repairs shall be charged for in the following cases.
 1. Failure occurring from inappropriate storage or handling, carelessness or negligence by the user. Failure caused by the user's hardware or software design.
 2. Failure caused by unapproved modifications, etc., to the product by the user.
 3. When the Mitsubishi product is assembled into a user's device, Failure that could have been avoided if functions or structures, judged as necessary in the legal safety measures the user's device is subject to or as necessary by industry standards, had been provided.
 4. Failure that could have been avoided if consumable parts (battery, backlight, fuse, etc.) designated in the instruction manual had been correctly serviced or replaced.
 5. Relay failure or output contact failure caused by usage beyond the specified life of contact (cycles).
 6. Failure caused by external irresistible forces such as fires or abnormal voltages, and failure caused by force majeure such as earthquakes, lightning, wind and water damage.
 7. Failure caused by reasons unpredictable by scientific technology standards at time of shipment from Mitsubishi.
 8. Any other failure found not to be the responsibility of Mitsubishi or that admitted not to be so by the user.

2. Onerous repair term after discontinuation of production

- (1) Mitsubishi shall accept onerous product repairs for seven (7) years after production of the product is discontinued.
Discontinuation of production shall be notified with Mitsubishi Technical Bulletins, etc.
- (2) Product supply (including repair parts) is not available after production is discontinued.

3. Overseas service

Overseas, repairs shall be accepted by Mitsubishi's local overseas FA Center. Note that the repair conditions at each FA Center may differ.

4. Exclusion of loss in opportunity and secondary loss from warranty liability

Regardless of the gratis warranty term, Mitsubishi shall not be liable for compensation to:

- (1) Damages caused by any cause found not to be the responsibility of Mitsubishi.
- (2) Loss in opportunity, lost profits incurred to the user by Failures of Mitsubishi products.
- (3) Special damages and secondary damages whether foreseeable or not, compensation for accidents, and compensation for damages to products other than Mitsubishi products.
- (4) Replacement by the user, maintenance of on-site equipment, start-up test run and other tasks.

5. Changes in product specifications

The specifications given in the catalogs, manuals or technical documents are subject to change without prior notice.

6. Product application

- (1) In using the Mitsubishi MELSEC programmable controller, the usage conditions shall be that the application will not lead to a major accident even if any problem or fault should occur in the programmable controller device, and that backup and fail-safe functions are systematically provided outside of the device for any problem or fault.
- (2) The Mitsubishi programmable controller has been designed and manufactured for applications in general industries, etc. Thus, applications in which the public could be affected such as in nuclear power plants and other power plants operated by respective power companies, and applications in which a special quality assurance system is required, such as for railway companies or public service purposes shall be excluded from the programmable controller applications.
In addition, applications in which human life or property that could be greatly affected, such as in aircraft, medical applications, incineration and fuel devices, manned transportation, equipment for recreation and amusement, and safety devices, shall also be excluded from the programmable controller range of applications. However, in certain cases, some applications may be possible, providing the user consults their local Mitsubishi representative outlining the special requirements of the project, and providing that all parties concerned agree to the special circumstances, solely at the user's discretion.
- (3) Mitsubishi shall have no responsibility or liability for any problems involving programmable controller trouble and system trouble caused by DoS attacks, unauthorized access, computer viruses, and other cyberattacks.

TRADEMARKS

Anywire and AnyWireASLINK are either registered trademarks or trademarks of Anywire Corporation.

The company names, system names and product names mentioned in this manual are either registered trademarks or trademarks of their respective companies.

In some cases, trademark symbols such as [™] or [®] are not specified in this manual.

Manual number: SH(NA)-081799ENG-E

Model: FX5-U-LC-E

Model code: 09R570

When exported from Japan, this manual does not require application to the Ministry of Economy, Trade and Industry for service transaction permission.

mitsubishi electric corporation

HEAD OFFICE: TOKYO BUILDING, 2-7-3 MARUNOUCHI, CHIYODA-KU, TOKYO 100-8310, JAPAN

Specifications are subject to change without notice.